



## *Baltur, smart solutions.*

Since 1950 Baltur has been designing and producing smart systems for the climate control of civil and industrial environments. It is a leading company in terms of technological developments in this field and has steadily grown to become one of the major players in the market. Baltur's successes are due to its strengths in the following areas: the quality of its products and its specialised services, its customer relations, its research, development and training, the new technology it employs and its respect for the environment. Baltur is the ideal partner for all those operating in the climate control sector and was indeed one of the first to obtain ISO 9001 certification. The company's products are the result of continuous research, some of which is carried out in collaboration with prestigious research institutes, while the products themselves are built to the highest technological levels. Anti-drip and anti-pollution systems and air-gas premixing are just a few of the ways efficiency is maintained and any environmental impact is minimised. There are five main product lines that provide a wide range that can also be tailored to the particular needs of the customer. The low NOx and CO emission BGN burners, the BTL burners, the GI 1000 burners for industrial boilers, are among the models bearing the mark of Baltur technology.

## *Baltur, in the world, one mission, one vision, one goal: conscientious energy management.*

Designing, manufacturing and selling "intelligent" solutions for heating, climate control, and applications for industry and its processes, managing energy rationally and effectively, while respecting both people and nature: this is how Baltur helps protect the environment.

This means standing out for the excellent quality of our products, and the great attention we pay to our customers.

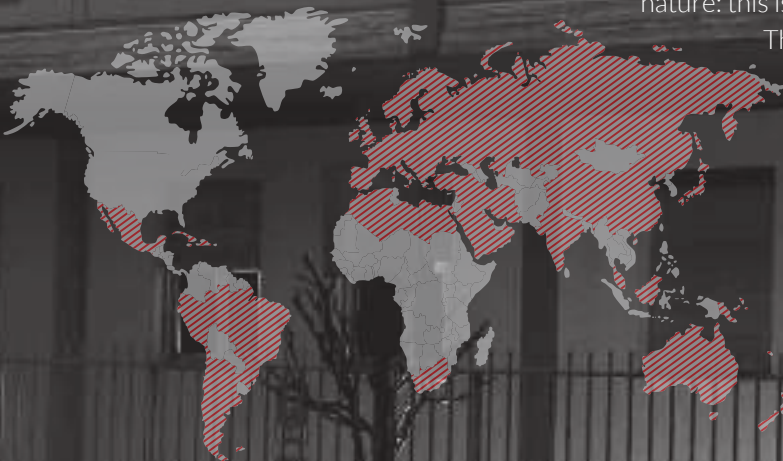



## BALTUR BURNERS

HIGH PERFORMANCE AND EMISSIONS  
REDUCTION - A WINNING COMBINATION  
FOR BALTUR BURNERS

BALTUR BURNERS ARE GUARANTEED BY THE EXPERIENCE AND KNOW-HOW ACQUIRED DURING 65 YEARS OF PRODUCTION, RESEARCH AND CONTINUOUS INVESTMENT. THE LINE IS TESTED ACCORDING TO ESTABLISHED PROCESSES, WHICH ARE COMPLIANT WITH EU AND EXTRA-EU STANDARDS, AT THE RESEARCH AND TESTING ROOM - A STATE-OF-THE-ART FACILITY FOR THE DEVELOPMENT OF THE BEST TECHNOLOGIES IN THE FIELD OF ENERGY EFFICIENCY.



ENERGY  
SAVING



COMFORT  
HIGH



RESPECT FOR THE  
ENVIRONMENT

## FEATURES THAT MAKE A DIFFERENCE

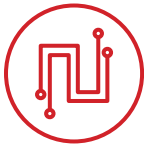

### Electronic modulation burners

- Easy to regulate thanks to the user-friendly electronic cam software.
- The regulation of the burner is more precise, reliable and repeatable.
- Higher modulation ratio.
- Highly flexible burner configuration according to customer requirements thanks to the modularity of the components that can be used provided by the electronic cam.
- Possibility of using Combustion Control Systems CCS for combustion optimization and energy saving.



### Low emissions gas burners

- The Baltur low emission burners have also been designed to be used in conjunction with combustion control systems.
- The installed electric power of the fan motors is lower than that of most competitors.
- The Baltur low NOx emissions burners can also be used in industrial processing plants.



### Burners with INVERTER frequency converter

- During normal operation, these allow a significant reduction in primary electrical energy consumption to be achieved, within the burner's modulation range.
- They guarantee a reduction in the amount of noise produced.
- The Baltur electronic cam burners can also use the inverter to manage combustion optimization in SCC combustion control systems.



### Burners with O<sub>2</sub> and CO control

- Our extensive experience in the configuration, management and installation of active SCC combustion control systems comes from having implemented hundreds of systems over the last 20 years.
- High reliability and consistency in the measurement, control and processing of the monitored parameters.
- Possibility of subsequent SCC system installation; its modular design means that the SCC system can be installed even after the burner has been installed and is operational.
- Integration of active O<sub>2</sub> and CO measuring devices for implementing continuous emissions monitoring systems (EMS) according to Legislative Decree No. 152.



### Burners with external recirculation of combustion gases FGR (Flue Gas Recirculation)

- The monobloc and dual block burners can be configured to use exhaust gases from the flue, to reduce nitrogen oxide NOx emissions.
- This system makes it possible to obtain a reduction of between 20% and 70% of nitrogen oxide, according to the amount of flue gas recirculated.
- Baltur provides engineering analysis for the FGR systems by providing technical support for the design of the flue gas systems.

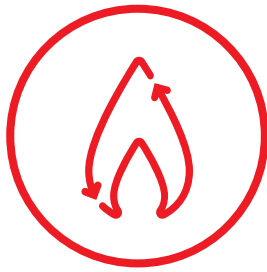

## WARNINGS

The following must be taken into account when choosing a burner:

### 1- COUPLING FLANGE

1.1- All burners are equipped with a coupling sliding flange which allows the exact positioning of the combustion head inside the combustion chamber in compliance with the boiler manufacturer's rules. This does not apply BTL 3, BTG 3, TBG 800/1100/1200/1600, TBML 350/600/800, GI 1000, GI MIST 1000. On request BTL 3 and BTG 3 can be supplied with a long head sliding on the coupling flange.

### 2 - PRESSURE JET BURNERS

2.1 - Blown air burners capacity is closely linked to the back-pressure in the combustion chamber. To ensure that you choose the right model it is necessary to examine the flow-rate/pressure diagrams given in the brochures and technical documentation.  
2.2 - Blown air burners can be used on pressurised or suction pressure boilers without any special adaptation.

### 3 - MODULATING BURNERS

3.1 - In case modulating burner is required it's necessary to add the PID load controller and related probe modulating KIT to the two stage progressive burner.

### 4 - GAS AND DUAL FUEL BURNERS

4.1 - Gas and mixed fuel burners comply with Directive 2009/142/EC and are manufactured according to EN676. This compliance is indicated by the CE mark on the burner itself. The standard EN676 requires the manufacturer to supply the gas pressure regulator (stabilizer) and the filter together with the burner.  
4.2 - Gas and mixed fuel burners, excluding COMIST ... DSP and GI MIST... , must always be ordered with a gas train and an adapter, if required. These should be selected according to the gas pressure available at the input of

the regulator, the amount of gas required, as well as the backpressure in the combustion chamber.

ORDERS FOR BURNERS WITHOUT A GAS TRAIN WILL NOT BE ACCEPTED.

4.3 - All gas and mixed burner trains are delivered pre-assembled and pre-wired.

4.4 - In the case of mains pressures different from those indicated, please contact our Sales Office for a quotation that will indicate either an additional charge or a price reduction subject to the exact calculation of the gas train.

4.5 - The gas supply system must comply with current regulations.

### 5 - DIESEL AND BIOFUEL BURNERS

5.1 - Diesel burners are also compatible with blends of diesel and biofuel only if the biofuel meets the requirements of EN14213 and the blend must be supplied by companies having an UNI-EN-ISO9000 certified quality system. With diesel and biofuel blends having a maximum biofuel content of 10%, all the components of the suction line of the system must be compatible with the type of fuel used and the line must be fitted with a filter (40µm rated) that can be inspected and cleaned periodically.

By following the guidelines described above and replacing the hoses every year (or installing special hoses), diesel burners can also be used with diesel and biofuel blends with a biofuel content of up to 30%.

### 6 - SERIES LX LIGHT OIL BURNERS

6.1 - Series LX light oil burners are suitable for combustion chambers with flue outlet from the chamber base (e.g. 3-pass boilers). They cannot be installed on reverse flame boilers.

The burner has been assessed on test boilers in compliance with the provisions of European standard EN267.

For combustion chamber dimensions that differ with respect to EN267 consult our



technical service department.

### **7 - HEAVY OIL BURNERS**

7.1 – If you use heavy oil with a viscosity higher than 5° E at 50°C and up to 15°E the system must be equipped with a feed circuit employing an auxiliary pump as per our technical drawings.

The same can be said when fuel viscosity is higher than 15°E at 50°C, yet in this event it is also necessary to install burners from the DSNM-D, DSPN-D and GI DSPN-D series.

### **8 - "WITHOUT" BURNERS**

8.1 – Light oil and gas burners marked with a W (Without) provide the same output and performance as standard models; although they are without a cover, they nevertheless remain compact and stylish.

### **9 - 60Hz BURNERS**

9.1 – The operating range of the burners has been obtained in compliance with EN267 (Light oil burners) and EN676 (Gas burners) with frequency 50Hz.

### **10 - IMPORTANT NOTES**

10.1 – Diagrams are indicative only and refer to test boilers as per the standards in force.

In practice there may be differences, which stem from the following factors:

- a) The capacity/incapacity of the burner to overcome the backpressure on ignition (different from standard operating pressure), which varies from boiler to boiler.
- b) High thermal load in the combustion chamber (relationship between combustion chamber output and relative volume - kW/m<sup>3</sup>) so the burner fan might not allow utilisation of the entire operating field.

### **11 - NOTES**

11.1 – This catalogue cancels and takes the place of all previous ones.

11.2 – Request availability of products while stocks last.

11.3 – For technical datas and special products offers please refer to the local Baltur dealer or contact directly Baltur Head Office attel. +39 0516843711,

fax +39 0516857529, e-mail info@baltur.it

11.4 – For information not contained in this catalogue (terms of delivery – installation instructions – special regulations etc.) refer to the specific materials (brochures – technical instructions etc.) and/or our authorised technical centres.

**ALL DATA IS INDICATIVE ONLY; BALTUR RESERVES THE RIGHT TO MODIFY TECHNICAL DATA AND OTHER INFORMATION ON THE CATALOGUE WITHOUT GIVING PRIOR NOTICE.**

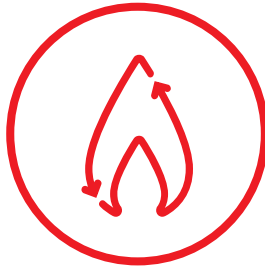

## SYMBOLOLOGY

### GAS

#### **BPM...**

Modulating gas premix burners.

#### **BTG... • TBG...**

Single-stage gas burners .

#### **BTG...P • TBG...P • TBG...LX P**

Two-stage gas burners.

#### **TBG...MC • TBG... LX MC**

Two-stage progressive/modulating gas burners with mechanical cam.

#### **BTG 20 LX • TBG...PN • TBG...LX PN**

Two-stage progressive/modulating gas burners with pneumatic regulation.

#### **BTG...ME • TBG...ME • TBG...LX ME**

Two-stage progressive / modulating gas burners with electronic cam.

#### **TBG...ME V • TBG...LX ME V**

Modulating gas burners with electronic modulation and frequency converter (inverter).

#### **COMIST...DSPGM • GI MIST...DSPGM**

Two-stage progressive/modulating gas/light oil burners with mechanical cam.  
Dual operation mode.

#### **TBML 50/80/120/160/200/260/360 ME**

Modulating gas/light oil burners with electronic modulation on gas, two-stage on light oil. Dual operating mode.

#### **TBML 350/600/800 ME**

Modulating gas/light oil burners with electronic modulation. Dual operating mode.

#### **COMIST...N • COMIST...NM**

Two-stage gas/heavy oil burners.  
Dual operation mode.

#### **COMIST...DSPNM**

Two-stage progressive/modulating gas/heavy oil burners with mechanical cam.  
Dual operating mode.

#### **GI MIST...DSPNM-D**

Two-stage progressive/modulating gas/extra heavy oil burners with mechanical cam.  
Dual operating mode.

### DUAL FUEL

#### **MINICOMIST... • COMIST 20**

Single-stage gas/light oil burners.  
Dual operating mode.

#### **COMIST 26 SP**

Two-stage pressure-drop gas/light oil burner.  
Dual operating mode.

#### **TBML...P**

Two-stage gas/light oil burners.  
Dual operating mode.

#### **TBML...MC**

Two-stage progressive/modulating gas/light oil burners with mechanical cam on gas, two-stage on light oil.  
Dual operating mode.

### LIGHT OIL

#### **BTL... • RiNOx...L • SPARK 35**

Single-stage light oil burners.

#### **BTL...P • RiNOx...L2 • SPARK 35 DSG • SPARK 35 LX • TBL... P • TBL...LX •**

**BT 300 DSG 4T • BT 350 DSG**  
Two-stage light oil burners.

#### **BT...DSPG • GI...DSPG**

Two-stage progressive/modulating light oil burners with mechanical cam.

### HEAVY OIL

#### **BT 17 N**

Single-stage heavy oil burner.

**BT...SPN**

Two-stage pressure drop heavy oil burners.

**BT...DNS 4T**

Two-stage heavy oil burners.

**BT...DSNM-D**

Two-stage extra heavy oil burners.

**BT...DSPN**

Two-stage progressive/modulating heavy oil burners with mechanical cam.

**GI...DSPN-D**

Two-stage progressive/modulating extra heavy oil burners with mechanical cam.

**...DACA**

Burner equipped with automatic air closure device.

**...O2**Burner equipped with control O<sub>2</sub>**...CO**

Burner equipped with control CO

**...H**

Burner equipped with preheating.

**...W**

Burner does not have a fairing.

**N.B.** The letters indicate the model; burner power is indicated in the spaces.

**GAS EMISSIONS:**  
Emissions classes defined according to EN676 directive.

Class	NOx Emissions [mg/kWh]	
	natural gas	GPL
1	≤ 170	≤ 230
2	≤ 120	≤ 180
3	≤ 80	≤ 140

**LIGHT OIL EMISSIONS:**  
Emissions classes defined according to EN267 directive.

Class	NOx Emissions	CO Emissions
	[mg/kWh]	[mg/kWh]
1	≤ 250	≤ 110
2	≤ 185	≤ 110
3	≤ 120	≤ 60



## Symbology

**BTL...  
RINOX...L  
SPARK 35**  
Single-stage  
light oil burners.

**BTL...P  
RINOX...L2  
SPARK 35 DSG  
SPARK 35 LX  
TBL... P  
TBL...LX  
BT 300 DSG 4T  
BT 350 DSG**  
Two-stage light  
oil burners.

**BT... DSPG  
GI...DSPG**  
Two-stage  
progressive/  
modulating light  
oil burners with  
mechanical cam.

 Low NOx

## SINGLE-STAGE LIGHT OIL BURNERS

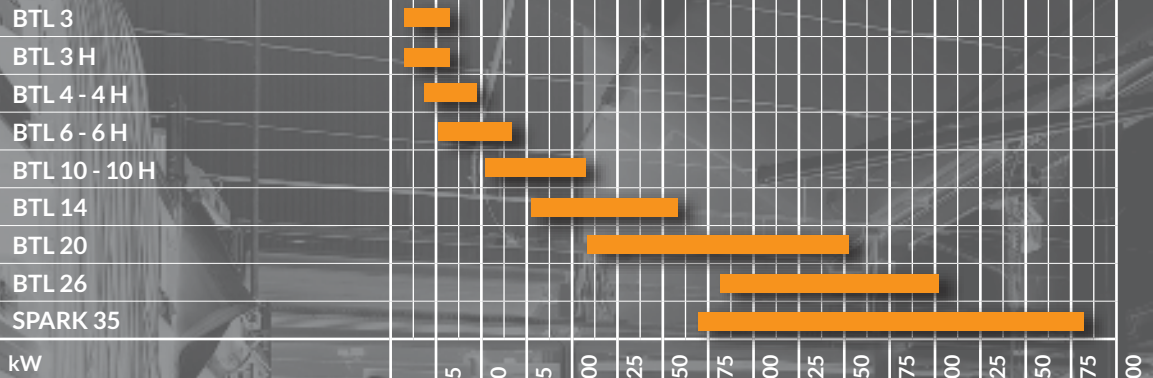

## TWO-STAGE LIGHT OIL BURNERS

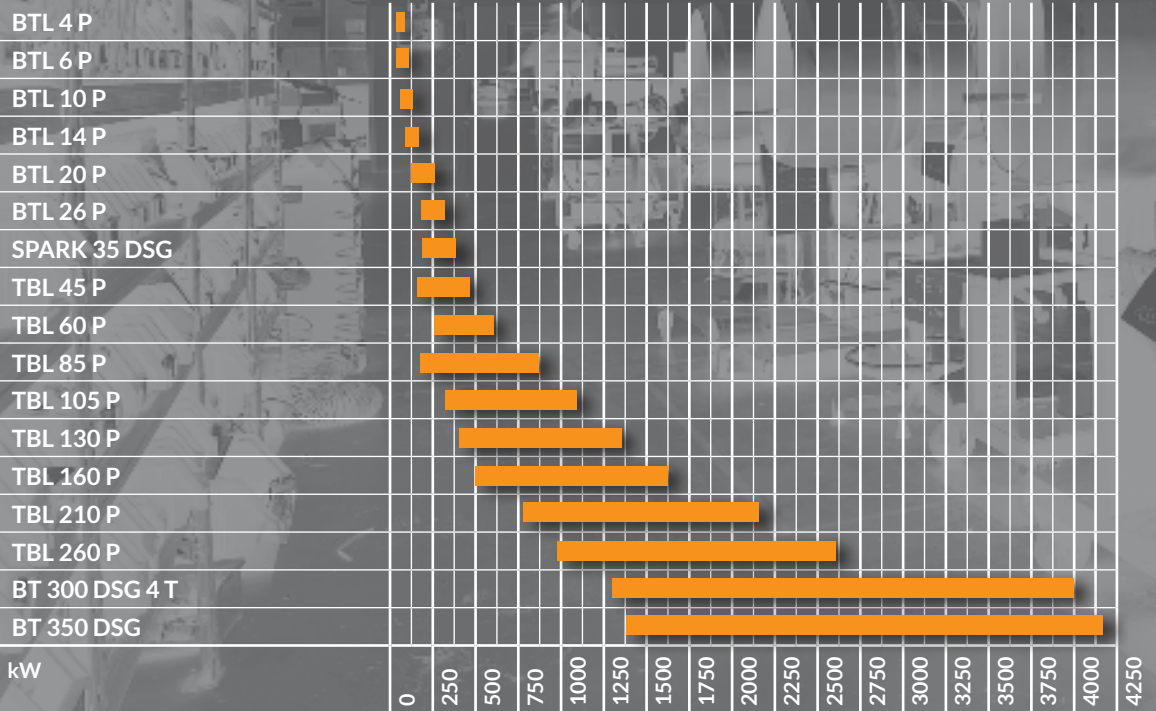

## LOW NOX LIGHT OIL BURNERS

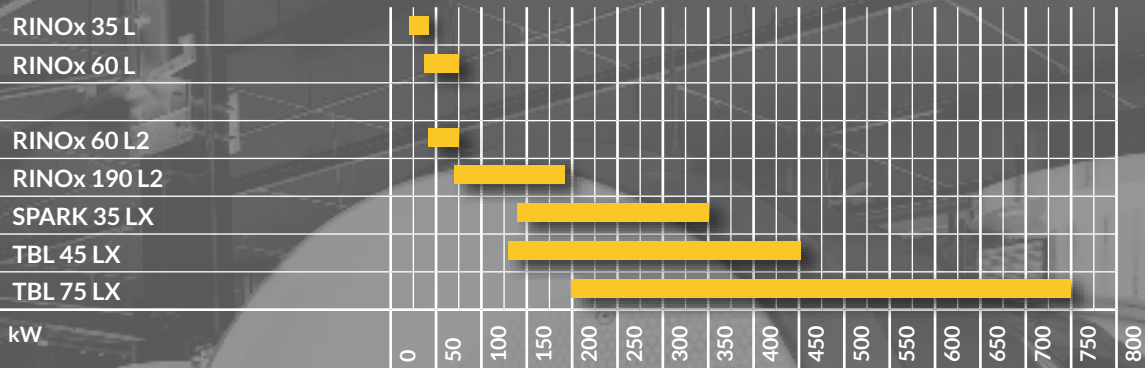

## TWO-STAGE PROGRESSIVE LIGHT OIL BURNERS

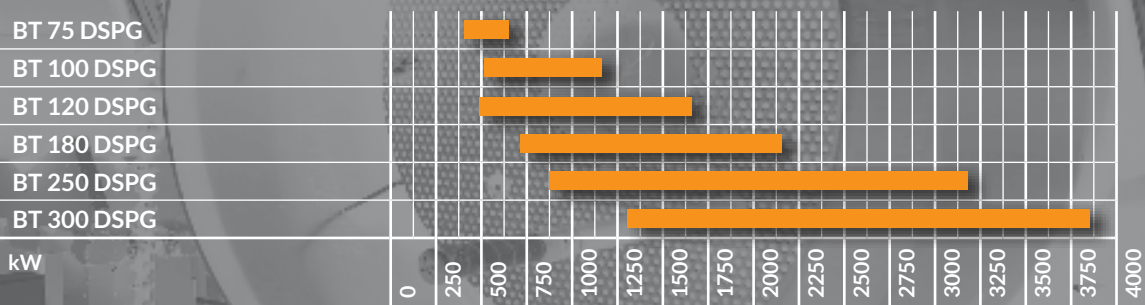

## TWO-STAGE PROGRESSIVE LIGHT OIL INDUSTRIAL BURNERS

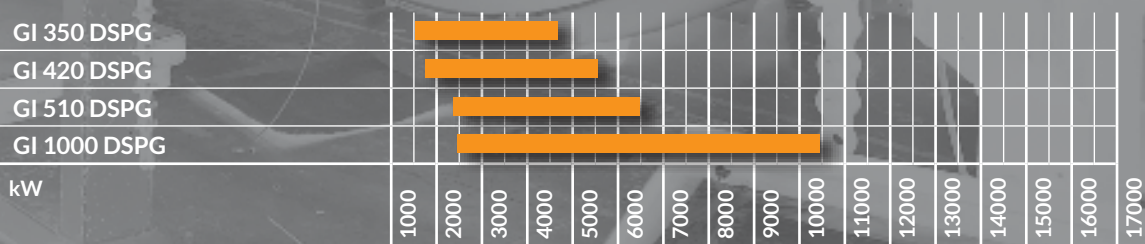



### Light oil burner. Operation:

Low NOx and CO emissions light oil burner according to European standard EN267:

Adjusting the combustion head.

Maintenance facilitated by the possibility of removing the combustion head without having to remove the burner from the boiler.

Fixed boiler coupling flange.

Sliding boiler coupling flange to adapt the blast-pipe to the various types of boilers.

Combustion air intake with butterfly valve. Air flow adjustment:

Fully closing air damper on shutdown to avoid loss of heat through the chimney.

Fuel supply circuit made of gear pump with pressure adjustment and shut-off valves.

Light oil preheater with variable capacity.

Flame detection by photoresistance.

Electric protection rating:

Sound-proof plastic protective cover.

	BTL 3	BTL 3 H	RiNOx 35 L
	single-stage	single-stage	single-stage
Low NOx and CO emissions light oil burner according to European standard EN267:			class 3
Adjusting the combustion head.	•	•	•
Maintenance facilitated by the possibility of removing the combustion head without having to remove the burner from the boiler.	•	•	•
Fixed boiler coupling flange.	•	•	
Sliding boiler coupling flange to adapt the blast-pipe to the various types of boilers.			•
Combustion air intake with butterfly valve. Air flow adjustment:	manual	manual	manual
Fully closing air damper on shutdown to avoid loss of heat through the chimney.	•	•	•
Fuel supply circuit made of gear pump with pressure adjustment and shut-off valves.	•	•	•
Light oil preheater with variable capacity.		•	•
Flame detection by photoresistance.	•	•	•
Electric protection rating:	IP40	IP40	IP40
Sound-proof plastic protective cover.	•	•	•

LIGHT OIL

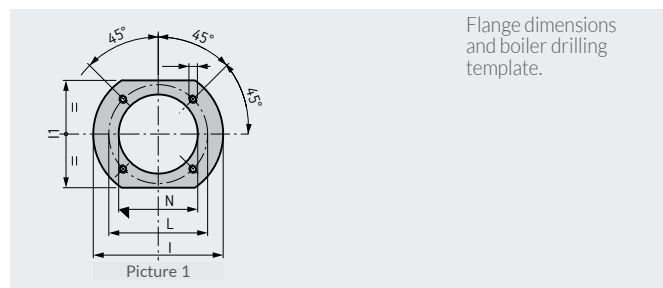
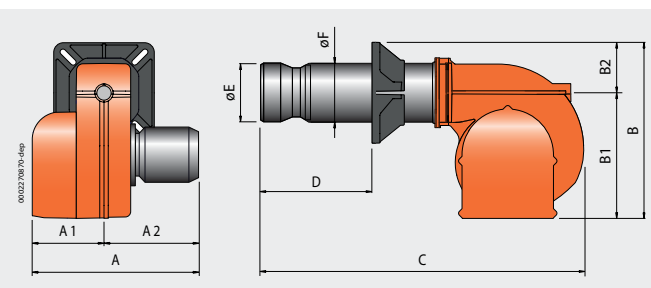

Flange dimensions and boiler drilling template.

Model	A mm	A1 mm	A2 mm	B mm	B1 mm	B2 mm	C mm	D mm	E mm	F mm	I mm	I1 mm	L mm	M mm	N mm	Pic.
BTL 3	250	120	130	242	170	72	330	90	80	80	170	144	135 ÷ 161	M8	85	1
BTL 3 H	250	120	130	242	170	72	330	90	80	80	170	144	135 ÷ 161	M8	85	1
RiNOx 35 L	246	123	123	289	219	70	410	50 ÷ 105	80	80	170	140	130 ÷ 155	M8	85	1

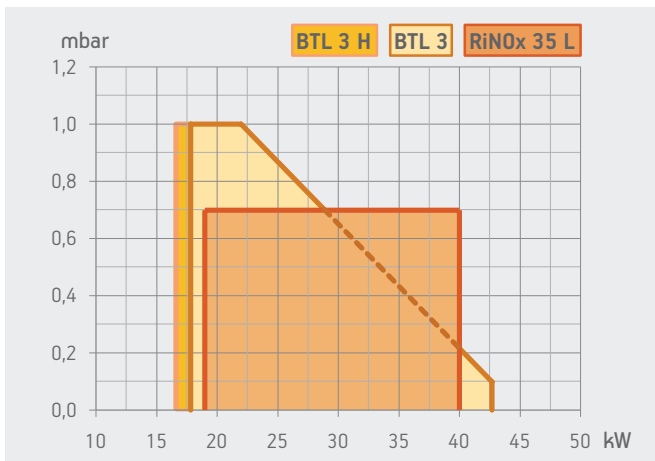

Model	Size of packaging			Weight kg
	L	P mm	H	
BTL 3	400	300	280	9
BTL 3 H	400	300	280	9
RiNOx 35 L	560	310	350	12

	Emissions class	Thermal output kW	Model	Part no.	Max visc. °E at 20°C	Electrical supply	Motor kW	Notes
Frequency 50 Hz								
	class 3	17,8 ÷ 42,7	<b>BTL 3</b>	<b>35450010</b>	1,5	1N AC 50Hz 230V	0,09	1)
		16,6 ÷ 42,7	<b>BTL 3 H</b>	<b>35450011</b>	1,5	1N AC 50Hz 230V	0,09	1) 2)
		19,0 ÷ 40,0	<b>RiNOx 35 L</b>	<b>35470050</b>	1,5	1N AC 50Hz 230V	0,10	1) 2)
Frequency 60 Hz								
		17,8 ÷ 42,7	<b>BTL 3</b>	<b>35450010</b>	1,5	1N AC 60Hz 220V	0,09	1)
		16,6 ÷ 42,7	<b>BTL 3 H</b>	<b>35450011</b>	1,5	1N AC 60Hz 220V	0,09	1) 2)

### OPTIONALS

#### DESCRIPTION

BTL 3/3 H: 200 mm long combustion head

Biodiesel operation (5)

### LIGHT OIL BURNER ACCESSORIES

Line filter, flex hoses, nozzle, boiler coupling kit, plug for wiring.

### NOTES

- 1 Equipped with air closure device.
- 2 Equipped with light oil pre-heater with drop-stop device.
- 5 Biodiesel according to european norm EN14213-FAME.  
Net calorific value of light oil: Hi = 42,70 MJ/kg = 10200 kcal/kg.



### Light oil burner. Operation:

Adjusting the combustion head.

Maintenance facilitated by the possibility of removing the combustion head without having to remove the burner from the boiler.

Sliding boiler coupling flange to adapt the blast-pipe to the various types of boilers.

Combustion air intake with butterfly valve. Air flow adjustment:

Fully closing air damper on shutdown to avoid loss of heat through the chimney.

Fuel supply circuit made of gear pump with pressure adjustment and shut-off valves.

Light oil preheater with variable capacity.

Flame detection by photoresistance.

Electric protection rating:

Sound-proof plastic protective cover.

	BTL 4	BTL 4 H	BTL 4 P
	single-stage	single-stage	two-stage
Adjusting the combustion head.	•	•	•
Maintenance facilitated by the possibility of removing the combustion head without having to remove the burner from the boiler.	•	•	•
Sliding boiler coupling flange to adapt the blast-pipe to the various types of boilers.	•	•	•
Combustion air intake with butterfly valve. Air flow adjustment:	manual	manual	electric servomotor
Fully closing air damper on shutdown to avoid loss of heat through the chimney.	•	•	•
Fuel supply circuit made of gear pump with pressure adjustment and shut-off valves.	•	•	•
Light oil preheater with variable capacity.		•	
Flame detection by photoresistance.	•	•	•
Electric protection rating:	IP40	IP40	IP40
Sound-proof plastic protective cover.	•	•	•

LIGHT OIL

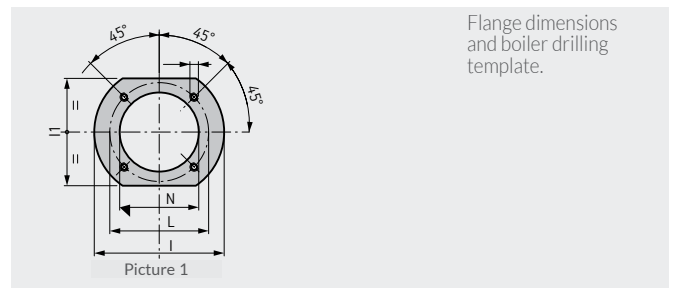
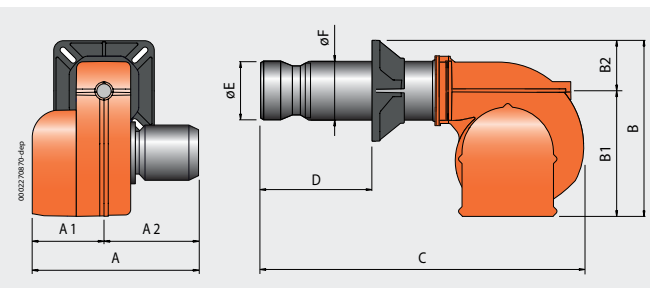

Model	A mm	A1 mm	A2 mm	B mm	B1 mm	B2 mm	C mm	D mm	E mm	F mm	I mm	I1 mm	L mm	M mm	N mm	Pic.
BTL 4	246	123	123	289	219	70	410	50 ÷ 105	80	80	170	140	130 ÷ 155	M8	85	1
BTL 4 H	246	123	123	289	219	70	410	50 ÷ 105	80	80	170	140	130 ÷ 155	M8	85	1
BTL 4 P	246	123	123	289	219	70	410	50 ÷ 105	80	80	170	140	130 ÷ 155	M8	85	1

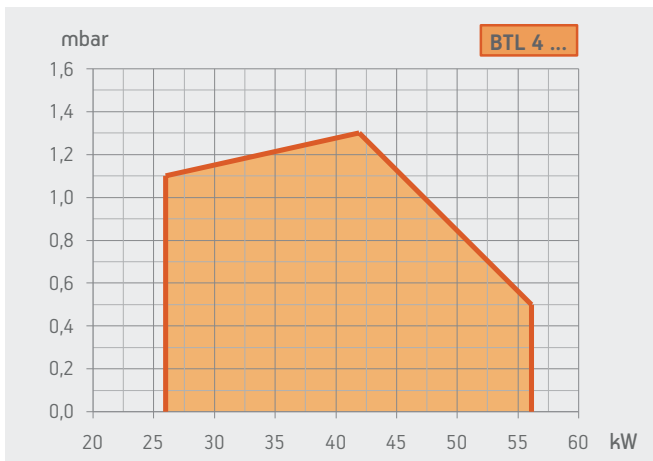

Model	Size of packaging			Weight kg
	L	P mm	H	
BTL 4	560	310	350	12
BTL 4 H	560	310	350	12
BTL 4 P	560	310	350	12

	Emissions class kW	Model	Part no.	Max visc. °E at 20°C	Electrical supply	Motor kW	Notes
Frequency 50 Hz							
	26,0 ÷ 56,1	<b>BTL 4</b>	<b>35490010</b>	1,5	1N AC 50Hz 230V	0,1	1)
	26,0 ÷ 56,1	<b>BTL 4 H</b>	<b>35490011</b>	1,5	1N AC 50Hz 230V	0,1	1) 2)
	26,0 ÷ 56,1	<b>BTL 4 P</b>	<b>35500010</b>	1,5	1N AC 50Hz 230V	0,1	1)
Frequency 60 Hz							
	26,0 ÷ 56,1	<b>BTL 4</b>	<b>35490010</b>	1,5	1N AC 60Hz 220V	0,1	1)
	26,0 ÷ 56,1	<b>BTL 4 H</b>	<b>35490011</b>	1,5	1N AC 60Hz 220V	0,1	1) 2)
	26,0 ÷ 56,1	<b>BTL 4 P</b>	<b>35500010</b>	1,5	1N AC 60Hz 220V	0,1	1)

### OPTIONALS

#### DESCRIPTION

200 mm long combustion head

Biodiesel operation (5)

### LIGHT OIL BURNER ACCESSORIES

Line filter, flex hoses, nozzle, boiler coupling kit, plug for wiring.

### NOTES

- 1 Equipped with air closure device.
- 2 Equipped with light oil pre-heater with drop-stop device.
- 5 Biodiesel according to european norm EN14213-FAME.  
Net calorific value of light oil: Hi = 42,70 MJ/kg = 10200 kcal/kg.



### Light oil burner. Operation:

Low NOx and CO emissions light oil burner according to European standard EN267:

Adjusting the combustion head.

Maintenance facilitated by the possibility of removing the combustion head without having to remove the burner from the boiler.

Sliding boiler coupling flange to adapt the blast-pipe to the various types of boilers.

Combustion air intake with butterfly valve. Air flow adjustment:

Fully closing air damper on shutdown to avoid loss of heat through the chimney.

Fuel supply circuit made of gear pump with pressure adjustment and shut-off valves.

Light oil preheater with variable capacity.

Flame detection by photoresistance.

Electric protection rating:

Sound-proof plastic protective cover.

	BTL 6	BTL 6 H	RiNOx 60 L	BTL 6 P	RiNOx 60 L2
	single-stage	single-stage	single-stage	two-stage	two-stage
Low NOx and CO emissions light oil burner according to European standard EN267:			class 3		class 3
Adjusting the combustion head.	•	•	•	•	•
Maintenance facilitated by the possibility of removing the combustion head without having to remove the burner from the boiler.	•	•	•	•	•
Sliding boiler coupling flange to adapt the blast-pipe to the various types of boilers.	•	•	•	•	•
Combustion air intake with butterfly valve. Air flow adjustment:	manual	manual	manual	electric servomotor	electric servomotor
Fully closing air damper on shutdown to avoid loss of heat through the chimney.	•	•	•	•	•
Fuel supply circuit made of gear pump with pressure adjustment and shut-off valves.	•	•	•	•	•
Light oil preheater with variable capacity.		•			
Flame detection by photoresistance.	•	•	•	•	•
Electric protection rating:	IP40	IP40	IP40	IP40	IP40
Sound-proof plastic protective cover.	•	•	•	•	•

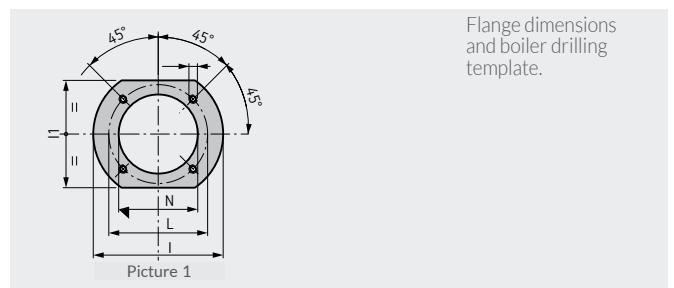
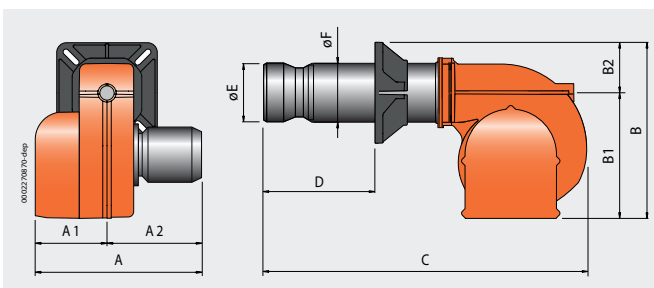

Model	A mm	A1 mm	A2 mm	B mm	B1 mm	B2 mm	C mm	D mm	E mm	F mm	I mm	I1 mm	L mm	M mm	N mm	Pic.
BTL 6	246	123	123	289	219	70	455	50 ÷ 150	90	90	170	140	130 ÷ 155	M8	95	1
BTL 6 H	246	123	123	289	219	70	455	50 ÷ 150	90	90	170	140	130 ÷ 155	M8	95	1
RiNOx 60 L	246	123	123	289	219	70	455	50 ÷ 150	90	90	170	140	130 ÷ 155	M8	95	1
BTL 6 P	246	123	123	289	219	70	455	50 ÷ 150	90	90	170	140	130 ÷ 155	M8	95	1
RiNOx 60 L2	246	123	123	289	219	70	455	50 ÷ 150	90	90	170	140	130 ÷ 155	M8	95	1

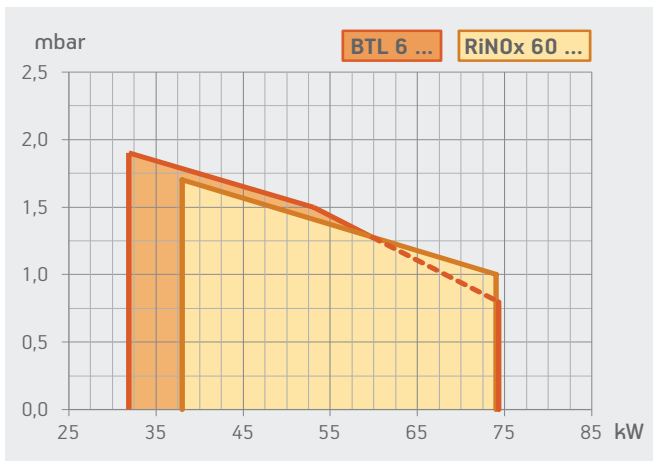

Model	Size of packaging			Weight kg
	L	P mm	H	
BTL 6	560	310	350	12
BTL 6 H	560	310	350	12
RiNOx 60 L	560	310	350	12
BTL 6 P	560	310	350	12
RiNOx 60 L2	560	310	350	12

	Emissions class	Thermal output kW	Model	Part no.	Max visc. °E at 20°C	Electrical supply	Motor kW	Notes
Frequency 50 Hz								
	class 3	31,9 ÷ 74,3	<b>BTL 6</b>	<b>35510010</b>	1,5	1N AC 50Hz 230V	0,1	1)
		31,9 ÷ 74,3	<b>BTL 6 H</b>	<b>35510011</b>	1,5	1N AC 50Hz 230V	0,1	1) 2)
		38,0 ÷ 74,0	<b>RiNOx 60 L</b>	<b>35510050</b>	1,5	1N AC 50Hz 230V	0,1	1)
	class 3	31,9 ÷ 74,3	<b>BTL 6 P</b>	<b>35520010</b>	1,5	1N AC 50Hz 230V	0,1	1)
		38,0 ÷ 74,0	<b>RiNOx 60 L2</b>	<b>35520050</b>	1,5	1N AC 50Hz 230V	0,1	1)
Frequency 60 Hz								
		31,9 ÷ 74,3	<b>BTL 6</b>	<b>35510010</b>	1,5	1N AC 60Hz 220V	0,1	1)
		31,9 ÷ 74,3	<b>BTL 6 H</b>	<b>35510011</b>	1,5	1N AC 60Hz 220V	0,1	1) 2)
		31,9 ÷ 74,3	<b>BTL 6 P</b>	<b>35520010</b>	1,5	1N AC 60Hz 220V	0,1	1)

### OPTIONALS

#### DESCRIPTION

BTL 6/6 H/6 P: 250 mm long combustion head

Biodiesel operation (5)

### LIGHT OIL BURNER ACCESSORIES

Line filter, flex hoses, nozzle, boiler coupling kit, plug for wiring.

### NOTES

- 1 Equipped with air closure device.
- 2 Equipped with light oil pre-heater with drop-stop device.
- 5 Biodiesel according to european norm EN14213-FAME.  
Net calorific value of light oil: Hi = 42,70 MJ/kg = 10200 kcal/kg.





### Light oil burner. Operation:

Adjusting the combustion head.

Maintenance facilitated by the possibility of removing the combustion head without having to remove the burner from the boiler.

Sliding boiler coupling flange to adapt the blast-pipe to the various types of boilers.

Combustion air intake with butterfly valve. Air flow adjustment:

Fully closing air damper on shutdown to avoid loss of heat through the chimney.

Fuel supply circuit made of gear pump with pressure adjustment and shut-off valves.

Light oil preheater with variable capacity.

Flame detection by photoresistance.

Electric protection rating:

Sound-proof plastic protective cover.

	BTL 10	BTL 10 H	BTL 10 P
	single-stage	single-stage	two-stage
Adjusting the combustion head.	•	•	•
Maintenance facilitated by the possibility of removing the combustion head without having to remove the burner from the boiler.	•	•	•
Sliding boiler coupling flange to adapt the blast-pipe to the various types of boilers.	•	•	•
Combustion air intake with butterfly valve. Air flow adjustment:	manual	manual	electric servomotor
Fully closing air damper on shutdown to avoid loss of heat through the chimney.	•	•	•
Fuel supply circuit made of gear pump with pressure adjustment and shut-off valves.	•	•	•
Light oil preheater with variable capacity.		•	
Flame detection by photoresistance.	•	•	•
Electric protection rating:	IP40	IP40	IP40
Sound-proof plastic protective cover.	•	•	•

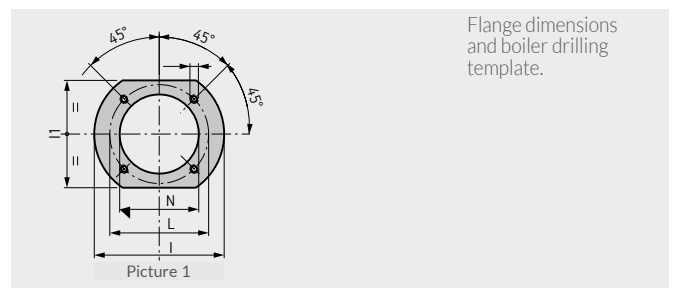
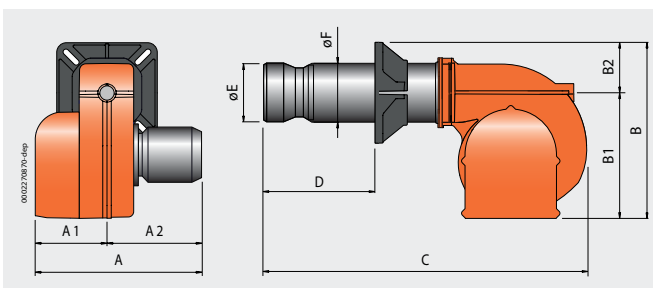

Model	A mm	A1 mm	A2 mm	B mm	B1 mm	B2 mm	C mm	D mm	E mm	F mm	I mm	I1 mm	L mm	M mm	N mm	Pic.
BTL 10	246	123	123	289	219	70	480	50 ÷ 158	90	90	170	140	130 ÷ 155	M8	95	1
BTL 10 H	246	123	123	289	219	70	480	50 ÷ 158	90	90	170	140	130 ÷ 155	M8	95	1
BTL 10 P	246	123	123	289	219	70	480	50 ÷ 158	90	90	170	140	130 ÷ 155	M8	95	1

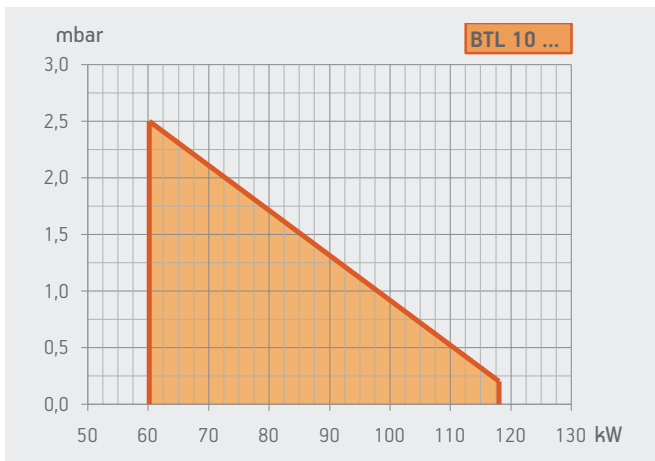

Model	Size of packaging			Weight kg
	L	P mm	H	
BTL 10	560	310	350	12
BTL 10 H	560	310	350	12
BTL 10 P	560	310	350	12

	Thermal output kW	Model	Part no.	Max visc. °E at 20°C	Electrical supply	Motor kW	Notes
Frequency 50 Hz							
	60,2 ÷ 118,0	<b>BTL 10</b>	<b>35530010</b>	1,5	1N AC 50Hz 230V	0,1	1)
	60,2 ÷ 118,0	<b>BTL 10 H</b>	<b>35530011</b>	1,5	1N AC 50Hz 230V	0,1	1) 2)
	60,2 ÷ 118,0	<b>BTL 10 P</b>	<b>35540010</b>	1,5	1N AC 50Hz 230V	0,1	1)
Frequency 60 Hz							
	60,2 ÷ 118,0	<b>BTL 10</b>	<b>35530010</b>	1,5	1N AC 60Hz 220V	0,1	1)
	60,2 ÷ 118,0	<b>BTL 10 H</b>	<b>35530011</b>	1,5	1N AC 60Hz 220V	0,1	1) 2)
	60,2 ÷ 118,0	<b>BTL 10 P</b>	<b>35540010</b>	1,5	1N AC 60Hz 220V	0,1	1)

### OPTIONALS

#### DESCRIPTION

250 mm long combustion head

Biodiesel operation (5)

### LIGHT OIL BURNER ACCESSORIES

Line filter, flex hoses, nozzle, boiler coupling kit, plug for wiring.

### NOTES

- 1 Equipped with air closure device.
- 2 Equipped with light oil pre-heater with drop-stop device.
- 5 Biodiesel according to european norm EN14213-FAME.  
Net calorific value of light oil: Hi = 42,70 MJ/kg = 10200 kcal/kg.



### Light oil burner. Operation:

Low NOx and CO emissions light oil burner according to European standard EN267:

Adjusting the combustion head.

Maintenance facilitated by the possibility of removing the combustion head without having to remove the burner from the boiler.

Sliding boiler coupling flange to adapt the blast-pipe to the various types of boilers.

Combustion air intake with butterfly valve. Air flow adjustment:

Fully closing air damper on shutdown to avoid loss of heat through the chimney.

Device made of sound-absorbing material to reduce fan noise.

Fuel supply circuit made of gear pump with pressure adjustment and shut-off valves.

Flame detection by photoresistance.

Electric protection rating:

Sound-proof plastic protective cover.

	BTL 14	BTL 14 P	RiNOx 190 L2
	single-stage	single-stage	two-stage
Low NOx and CO emissions light oil burner according to European standard EN267:			class 3
Adjusting the combustion head.	•	•	•
Maintenance facilitated by the possibility of removing the combustion head without having to remove the burner from the boiler.	•	•	•
Sliding boiler coupling flange to adapt the blast-pipe to the various types of boilers.	•	•	•
Combustion air intake with butterfly valve. Air flow adjustment:	manual	electric servomotor	electric servomotor
Fully closing air damper on shutdown to avoid loss of heat through the chimney.	•	•	•
Device made of sound-absorbing material to reduce fan noise.	•	•	•
Fuel supply circuit made of gear pump with pressure adjustment and shut-off valves.	•	•	•
Flame detection by photoresistance.	•	•	•
Electric protection rating:	IP40	IP40	IP40
Sound-proof plastic protective cover.	•	•	•

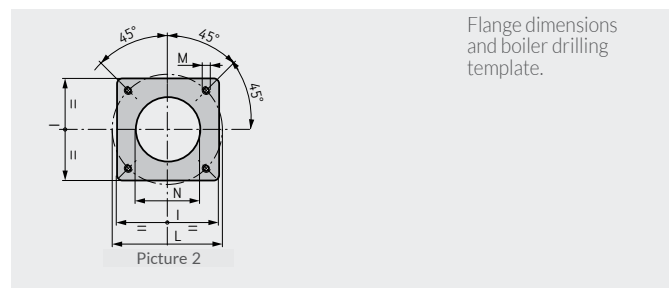
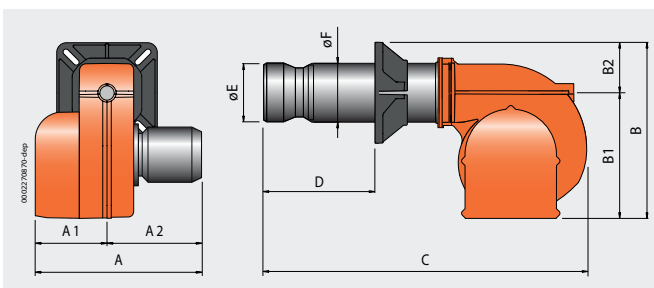

Model	A mm	A1 mm	A2 mm	B mm	B1 mm	B2 mm	C mm	D mm	E mm	F mm	I mm	L mm	M mm	N mm	Pic.
BTL 14	303	158	145	358	275	83	620	100 ÷ 250	100	100	166	150 ÷ 200	M10	110	2
BTL 14 P	303	158	145	358	275	83	620	100 ÷ 250	100	100	166	150 ÷ 200	M10	110	2
RiNOx 190 L2	303	158	145	358	275	83	620	100 ÷ 250	100	100	166	150 ÷ 200	M10	110	2

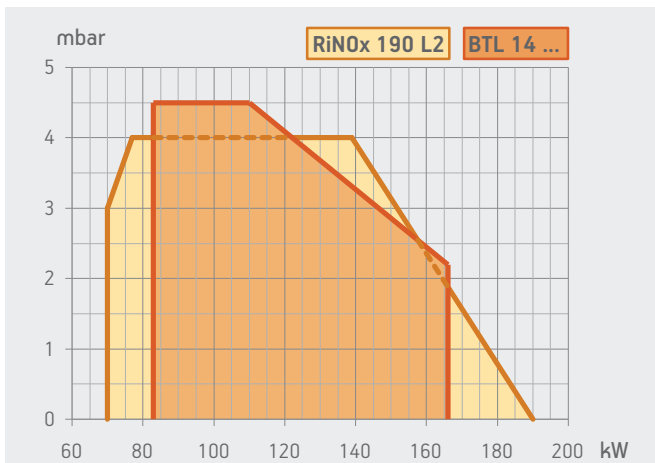

Model	Size of packaging			Weight kg
	L	P mm	H	
BTL 14	780	370	410	18
BTL 14 P	780	370	410	18
RiNOx 190 L2	780	370	410	18

	Emissions class	Thermal output kW	Model	Part no.	Max visc. °E at 20°C	Electrical supply	Motor kW	Notes
Frequency 50 Hz								
	class 3	83 ÷ 166	<b>BTL 14</b>	<b>35610010</b>	1,5	1N AC 50Hz 230V	0,18	1) 3)
		83 ÷ 166	<b>BTL 14 P</b>	<b>35620010</b>	1,5	1N AC 50Hz 230V	0,18	1) 3)
		70 ÷ 190	<b>RiNOx 190 L2</b>	<b>35640050</b>	1,5	1N AC 50Hz 230V	0,18	1) 3)
Frequency 60 Hz								
		83 ÷ 166	<b>BTL 14</b>	<b>35615410</b>	1,5	1N AC 60Hz 220V	0,25	1) 3)
		83 ÷ 166	<b>BTL 14 P</b>	<b>35625410</b>	1,5	1N AC 60Hz 220V	0,25	1) 3)

### OPTIONALS

#### DESCRIPTION

BTL 14/14 P: 500 mm long combustion head

Biodiesel operation (5)

### LIGHT OIL BURNER ACCESSORIES

Line filter, flex hoses, nozzle, boiler coupling kit, plug for wiring.

### NOTES

- 1 Equipped with air closure device.
- 3 Soundproof lid on burner air intake.
- 5 Biodiesel according to european norm EN14213-FAME.  
Net calorific value of light oil: Hi = 42,70 MJ/kg = 10200 kcal/kg.



### Light oil burner. Operation:

Adjusting the combustion head.

Maintenance facilitated by the possibility of removing the combustion head without having to remove the burner from the boiler.

Sliding boiler coupling flange to adapt the blast-pipe to the various types of boilers.

Combustion air intake with butterfly valve. Air flow adjustment:

Fully closing air damper on shutdown to avoid loss of heat through the chimney.

Device made of sound-absorbing material to reduce fan noise.

Fuel supply circuit made of gear pump with pressure adjustment and shut-off valves.

Flame detection by photoresistance.

Electric protection rating:

Sound-proof plastic protective cover.

	BTL 20	BTL 20 P
	single-stage	two-stage
Adjusting the combustion head.	•	•
Maintenance facilitated by the possibility of removing the combustion head without having to remove the burner from the boiler.	•	•
Sliding boiler coupling flange to adapt the blast-pipe to the various types of boilers.	•	•
Combustion air intake with butterfly valve. Air flow adjustment:	manual	electric servomotor
Fully closing air damper on shutdown to avoid loss of heat through the chimney.	•	•
Device made of sound-absorbing material to reduce fan noise.	•	•
Fuel supply circuit made of gear pump with pressure adjustment and shut-off valves.	•	•
Flame detection by photoresistance.	•	•
Electric protection rating:	IP40	IP40
Sound-proof plastic protective cover.	•	•

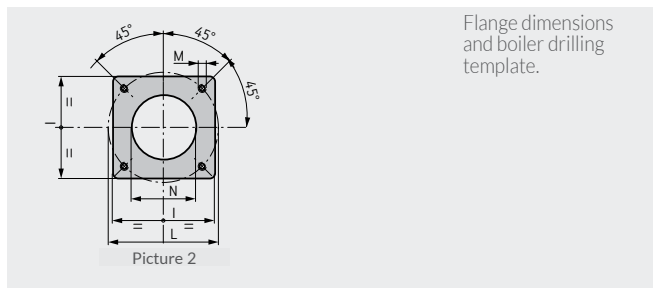
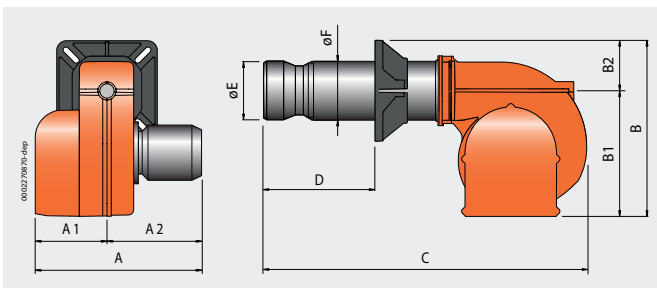

Flange dimensions and boiler drilling template.

Model	A mm	A1 mm	A2 mm	B mm	B1 mm	B2 mm	C mm	D mm	E mm	F mm	I mm	L mm	M mm	N mm	Pic.
BTL 20	303	158	145	368	275	93	645	100 ÷ 250	114	114	185	170 ÷ 210	M10	120	2
BTL 20 P	303	158	145	368	275	93	645	100 ÷ 250	114	114	185	170 ÷ 210	M10	120	2

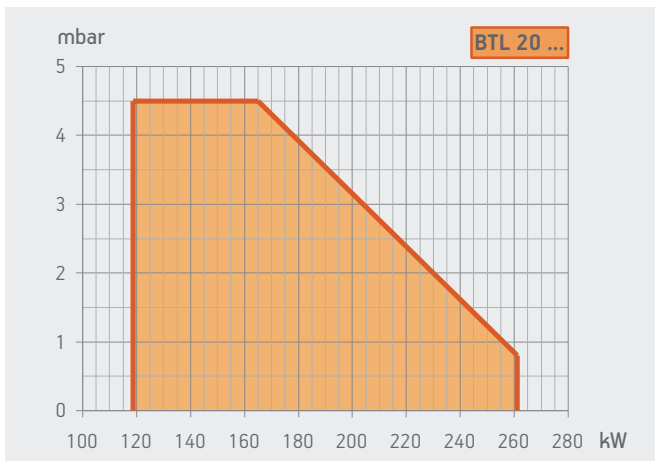

Model	Size of packaging			Weight kg
	L	P mm	H	
BTL 20	780	370	410	18
BTL 20 P	780	370	410	18

	Thermal output kW	Model	Part no.	Max visc. °E at 20°C	Electrical supply	Motor kW	Notes
Frequency 50 Hz							
	118,6 ÷ 261,0	<b>BTL 20</b>	<b>35630010</b>	1,5	1N AC 50Hz 230V	0,18	1) 3)
	118,6 ÷ 261,0	<b>BTL 20 P</b>	<b>35640010</b>	1,5	1N AC 50Hz 230V	0,18	1) 3)
Frequency 60 Hz							
	118,6 ÷ 261,0	<b>BTL 20</b>	<b>35635410</b>	1,5	1N AC 60Hz 220V	0,25	1) 3)
	118,6 ÷ 261,0	<b>BTL 20 P</b>	<b>35645410</b>	1,5	1N AC 60Hz 220V	0,25	1) 3)

## OPTIONALS

### DESCRIPTION

500 mm long combustion head

Biodiesel operation (5)

## LIGHT OIL BURNER ACCESSORIES

Line filter, flex hoses, nozzle, boiler coupling kit, plug for wiring.

## NOTES

- 1 Equipped with air closure device.
- 3 Soundproof lid on burner air intake.
- 5 Biodiesel according to european norm EN14213-FAME.  
Net calorific value of light oil: Hi = 42,70 MJ/kg = 10200 kcal/kg.



### Light oil burner. Operation:

Adjusting the combustion head.

Maintenance facilitated by the possibility of removing the combustion head without having to remove the burner from the boiler.

Sliding boiler coupling flange to adapt the blast-pipe to the various types of boilers.

Combustion air intake with butterfly valve. Air flow adjustment:

Device made of sound-absorbing material to reduce fan noise.

Fuel supply circuit made of gear pump with pressure adjustment and shut-off valves.

Flame detection by photoresistance.

Electric protection rating:

Sound-proof plastic protective cover.

	BTL 26	BTL 26 P
	single-stage	two-stage
Adjusting the combustion head.	•	•
Maintenance facilitated by the possibility of removing the combustion head without having to remove the burner from the boiler.	•	•
Sliding boiler coupling flange to adapt the blast-pipe to the various types of boilers.	•	•
Combustion air intake with butterfly valve. Air flow adjustment:	manual	electric servomotor
Device made of sound-absorbing material to reduce fan noise.	•	•
Fuel supply circuit made of gear pump with pressure adjustment and shut-off valves.	•	•
Flame detection by photoresistance.	•	•
Electric protection rating:	IP40	IP40
Sound-proof plastic protective cover.	•	•

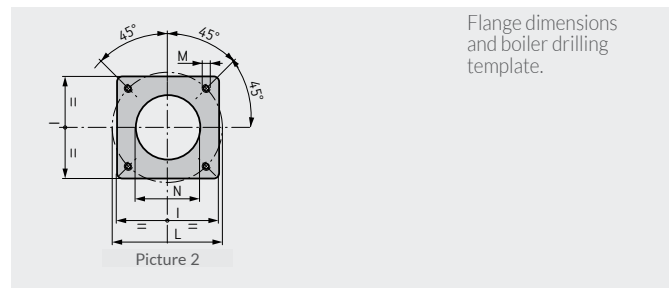
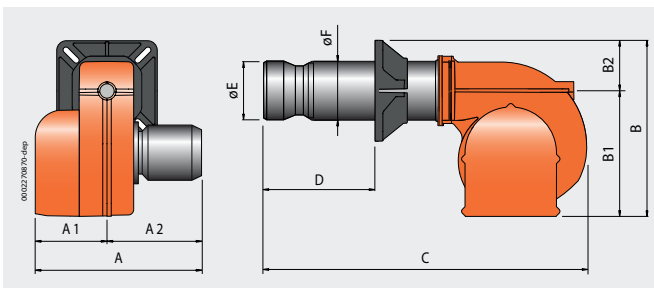

Model	A mm	A1 mm	A2 mm	B mm	B1 mm	B2 mm	C mm	D mm	E mm	F mm	I mm	L mm	M mm	N mm	Pic.
BTL 26	303	158	145	368	275	93	650	100 ÷ 255	135	135	185	170 ÷ 210	M10	140	2
BTL 26 P	303	158	145	368	275	93	650	100 ÷ 255	135	135	185	170 ÷ 210	M10	140	2

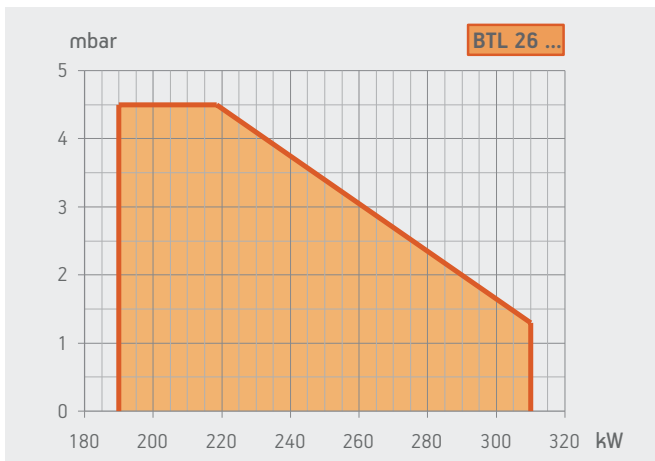

Model	Size of packaging			Weight kg
	L	P mm	H	
BTL 26	780	370	410	18
BTL 26 P	780	370	410	18

	Thermal output kW	Model	Part no.	Max visc. °E at 20°C	Electrical supply	Motor kW	Notes
Frequency 50 Hz							
	190 ÷ 310	<b>BTL 26</b>	<b>35650010</b>	1,5	1N AC 50Hz 230V	0,25	3)
	190 ÷ 310	<b>BTL 26 P</b>	<b>35660010</b>	1,5	1N AC 50Hz 230V	0,25	3)
Frequency 60 Hz							
	190 ÷ 310	<b>BTL 26</b>	<b>35655410</b>	1,5	1N AC 60Hz 220V	0,25	3)
	190 ÷ 310	<b>BTL 26 P</b>	<b>35665410</b>	1,5	1N AC 60Hz 220V	0,25	3)

### OPTIONALS

#### DESCRIPTION

500 mm long combustion head

Biodiesel operation (5)

### LIGHT OIL BURNER ACCESSORIES

Line filter, flex hoses, nozzle, boiler coupling kit, plug for wiring.

### NOTES

3 Soundproof lid on burner air intake.

5 Biodiesel according to european norm EN14213-FAME.

Net calorific value of light oil: Hi = 42,70 MJ/kg = 10200 kcal/kg.





SPARK 35 W - 35 DSG W



SPARK 35 - 35 DSG - 35 LX

	SPARK 35 W	SPARK 35	SPARK 35 DSG W	SPARK 35 DSG	SPARK 35 LX
<b>Light oil burner. Operation:</b>	single-stage	single-stage	two-stage	two-stage	two-stage
Low NOx and CO emissions light oil burner according to European standard EN267:					class 3
Adjusting the combustion head.	•	•	•	•	•
Maintenance facilitated by the possibility of removing the combustion head without having to remove the burner from the boiler.	•	•	•	•	•
Sliding boiler coupling flange to adapt the blast-pipe to the various types of boilers.	•	•	•	•	•
Combustion air intake with butterfly valve. Air flow adjustment:	manual	manual	electric servomotor	electric servomotor	electric servomotor
Fully closing air damper on shutdown to avoid loss of heat through the chimney.			•	•	•
Device made of sound-absorbing material to reduce fan noise.	•	•	•	•	•
Fuel supply circuit made of gear pump with pressure adjustment and shut-off valves.	•	•	•	•	•
Flame detection by photoresistance.	•	•	•	•	
Flame detection by IRD photocell.					•
Electric protection rating:	IP40	IP40	IP40	IP40	IP40
Sound-proof plastic protective cover.		•		•	•

LIGHT OIL

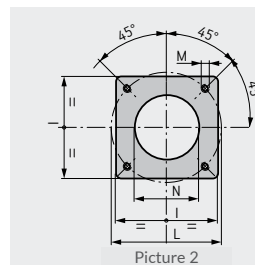
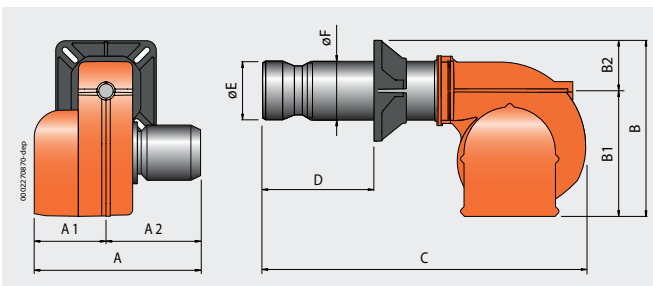

Flange dimensions and boiler drilling template.

Model	A mm	A1 mm	A2 mm	B mm	B1 mm	B2 mm	C mm	D mm	E mm	F mm	I mm	L mm	M mm	N mm	Pic.
SPARK 35 W	450	220	230	371	263	108	780	105 ÷ 350	150	135	215	200 ÷ 245	M12	155	2
SPARK 35	490	245	245	383	275	108	810	105 ÷ 350	150	135	215	200 ÷ 245	M12	155	2
SPARK 35 DSG W	450	220	230	371	263	108	780	105 ÷ 350	150	135	215	200 ÷ 245	M12	155	2
SPARK 35 DSG	490	245	245	383	275	108	810	105 ÷ 350	150	135	215	200 ÷ 245	M12	155	2
SPARK 35 LX	490	245	245	383	275	108	835	165 ÷ 305	136	136	215	200 ÷ 245	M12	150	2

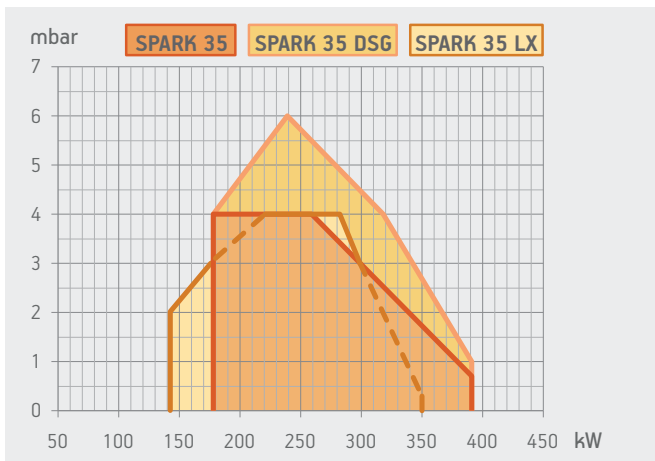

Model	Size of packaging			Weight kg
	L	P mm	H	
SPARK 35 W	940	490	390	30
SPARK 35	980	540	480	34
SPARK 35 DSG W	940	490	390	32
SPARK 35 DSG	980	540	480	36
SPARK 35 LX	980	540	480	36

	Emissions class	Thermal output kW	Model	Part no.	Max visc. °E at 20°C	Electrical supply	Motor kW	Notes
Frequency 50 Hz								
	class 3	178 ÷ 391	SPARK 35 W	3070010	1,5	1N AC 50Hz 230V	0,37	3)
		178 ÷ 391	SPARK 35	3071010	1,5	1N AC 50Hz 230V	0,37	3)
		178 ÷ 391	SPARK 35 DSG W	3075010	1,5	1N AC 50Hz 230V	0,37	3) 4)
		178 ÷ 391	SPARK 35 DSG	3076010	1,5	1N AC 50Hz 230V	0,37	3) 4)
		142 ÷ 350	SPARK 35 LX	33960010	1,5	1N AC 50Hz 230V	0,37	3) 4)
Frequency 60 Hz								
	class 3	178 ÷ 391	SPARK 35 W	30705410	1,5	1N AC 60Hz 220V	0,37	3)
		178 ÷ 391	SPARK 35	30715410	1,5	1N AC 60Hz 220V	0,37	3)
		178 ÷ 391	SPARK 35 DSG W	30755410	1,5	1N AC 60Hz 220V	0,37	3) 4)
		142 ÷ 350	SPARK 35 DSG	30765410	1,5	1N AC 60Hz 220V	0,37	3) 4)

### OPTIONALS

DESCRIPTION
SPARK 35/35 W/35 DSG/35 DSG W: 500 mm long combustion head
Biodiesel operation (5)

### ACCESSORIES AVAILABLE ON REQUEST

DESCRIPTION	Part no.
Soundproof burner cover (see page 299)	97980054

### LIGHT OIL BURNER ACCESSORIES

SPARK 35/35W: line filter, flex hoses, nozzle, boiler coupling kit, plug for wiring.  
 SPARK 35DSG/35DSG W: line filter, flex hoses, nozzles, boiler coupling kit, plug for wiring.

### NOTES

- 3 Soundproof lid on burner air intake.
- 4 Equipped with air closure device.
- 5 Biodiesel according to european norm EN14213-FAME.  
 Net calorific value of light oil: Hi = 42,70 MJ/kg = 10200 kcal/kg.



### Light oil burner. Operation:

Low NOx and CO emissions light oil burner according to European standard EN267:

Adjusting the combustion head.

Maintenance facilitated by the possibility of removing the combustion head without having to remove the burner from the boiler.

Sliding boiler coupling flange to adapt the blast-pipe to the various types of boilers.

Combustion air intake with butterfly valve. Air flow adjustment:

Fully closing air damper on shutdown to avoid loss of heat through the chimney.

Fuel supply circuit made of gear pump with pressure adjustment, shut-off valves and safety valve.

Flame detection by photoresistance.

Flame detection by IRD photocell.

Electric protection rating:

	TBL 45 P	TBL 45 P DACA	TBL 45 LX
	two-stage	two-stage	two-stage
	class 2	class 2	class 3
Adjusting the combustion head.	•	•	•
Maintenance facilitated by the possibility of removing the combustion head without having to remove the burner from the boiler.	•	•	•
Sliding boiler coupling flange to adapt the blast-pipe to the various types of boilers.	•	•	•
Combustion air intake with butterfly valve. Air flow adjustment:	hydraulic jack	electric servomotor	electric servomotor
Fully closing air damper on shutdown to avoid loss of heat through the chimney.		•	•
Fuel supply circuit made of gear pump with pressure adjustment, shut-off valves and safety valve.	•	•	•
Flame detection by photoresistance.	•	•	
Flame detection by IRD photocell.			•
Electric protection rating:	IP40	IP40	IP44

LIGHT OIL

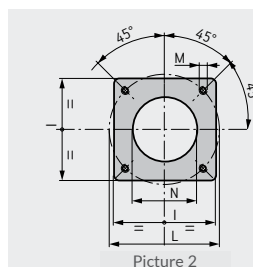
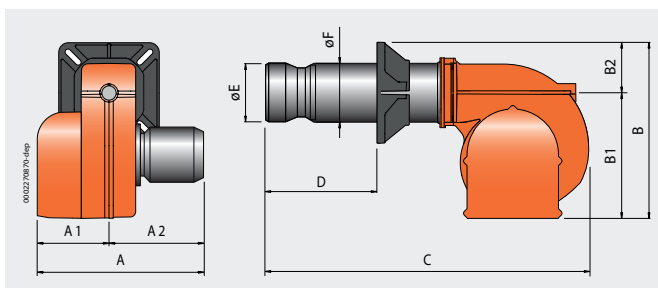

Flange dimensions and boiler drilling template.

Model	A mm	A1 mm	A2 mm	B mm	B1 mm	B2 mm	C mm	D mm	E mm	F mm	I mm	L mm	M mm	N mm	Pic.
TBG 45 P	505	260	245	433	325	108	820	120 ÷ 350	135	133	215	200 ÷ 245	M12	145	2
TBG 45 P DACA	535	260	275	433	325	108	860	120 ÷ 350	135	133	215	200 ÷ 245	M12	145	2
TBG 45 LX	535	260	275	433	325	108	860	120 ÷ 350	135	133	215	200 ÷ 245	M12	145	2

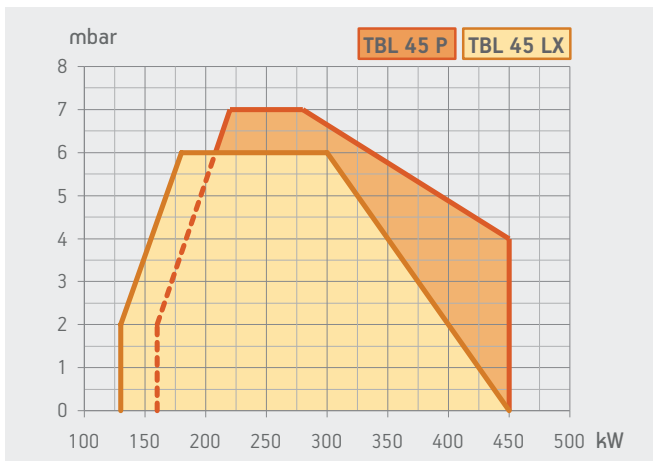

Model	Size of packaging			Weight kg
	L	P mm	H	
TBL 45 P	970	570	480	34
TBL 45 P DACA	970	570	480	34
TBL 45 LX	970	570	480	34

	Emissions class	Thermal output kW	Model	Part no.	Max visc. °E at 20°C	Electrical supply	Motor kW	Notes
Frequency 50 Hz								
	class 2	160 ÷ 450	TBL 45 P	35710010	1,5	1N AC 50Hz 230V	0,50	
	class 2	160 ÷ 450	TBL 45 P	35710015	1,5	3N AC 50Hz 400V	0,65	
	class 2	160 ÷ 450	TBL 45 P DACA	35710110	1,5	1N AC 50Hz 230V	0,50	4)
	class 3	130 ÷ 450	TBL 45 LX	35730010	1,5	1N AC 50Hz 230V	0,50	4)
Frequency 60 Hz								
	class 2	160 ÷ 450	TBL 45 P	35715410	1,5	1N AC 60Hz 220V	0,50	
	class 2	160 ÷ 450	TBL 45 P	35715415	1,5	1N AC 60Hz 380V	0,65	
	class 2	160 ÷ 450	TBL 45 P DACA	35715420	1,5	1N AC 60Hz 220V	0,50	4)

## OPTIONALS

DESCRIPTION
Biodiesel operation (5)

## ACCESSORIES AVAILABLE ON REQUEST

DESCRIPTION	PART NO.
TBL 45 P/45 P DACA: line filter 3/8"	98000370
Soundproof burner cover (see page 299)	97980054

## LIGHT OIL BURNER ACCESSORIES

TBL 45 P/45 P DACA: flex hoses, nozzles, boiler coupling kit, plug for wiring.  
 TBL 45 LX: line filter, flex hoses, nozzles, boiler coupling kit, plug for wiring.

## NOTES

- 4 Equipped with air closure device.
- 5 Biodiesel according to european norm EN14213-FAME.  
 Net calorific value of light oil: Hi = 42,70 MJ/kg = 10200 kcal/kg.



### Light oil burner. Operation:

Low NOx and CO emissions light oil burner according to European standard EN267:

Adjusting the combustion head.

Maintenance facilitated by the possibility of removing the combustion head without having to remove the burner from the boiler.

Sliding boiler coupling flange to adapt the blast-pipe to the various types of boilers.

Combustion air intake with butterfly valve. Air flow adjustment:

Fully closing air damper on shutdown to avoid loss of heat through the chimney.

Fuel supply circuit made of gear pump with pressure adjustment, shut-off valves and safety valve.

Flame detection by photoresistance.

Electric protection rating:

	TBL 60 P	TBL 60 P DACA
	two-stage	two-stage
	class 2	class 2
Adjusting the combustion head.	•	•
Maintenance facilitated by the possibility of removing the combustion head without having to remove the burner from the boiler.	•	•
Sliding boiler coupling flange to adapt the blast-pipe to the various types of boilers.	•	•
Combustion air intake with butterfly valve. Air flow adjustment:	hydraulic jack	electric servomotor
Fully closing air damper on shutdown to avoid loss of heat through the chimney.		•
Fuel supply circuit made of gear pump with pressure adjustment, shut-off valves and safety valve.	•	•
Flame detection by photoresistance.	•	•
Electric protection rating:	IP40	IP40

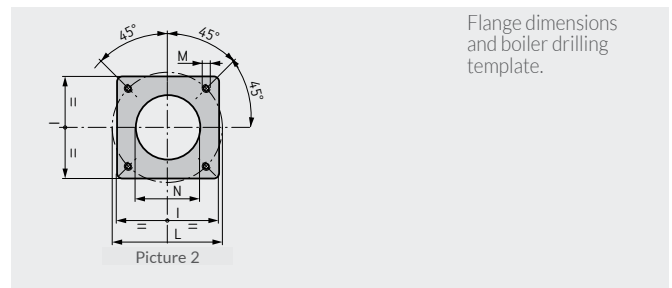
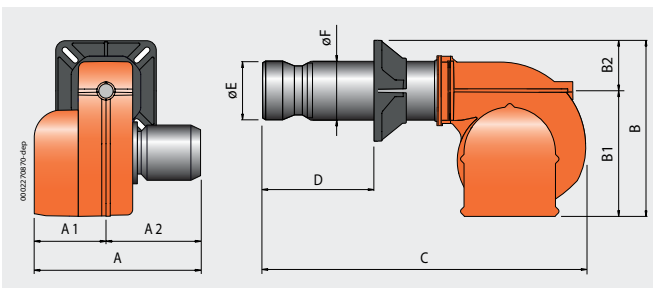

Model	A mm	A1 mm	A2 mm	B mm	B1 mm	B2 mm	C mm	D mm	E mm	F mm	I mm	L mm	M mm	N mm	Pic.
TBL 60 P	505	260	245	455	325	130	840	140 ÷ 350	150	152	260	225 ÷ 300	M12	160	2
TBL 60 P DACA	535	260	275	455	325	130	880	140 ÷ 350	150	152	260	225 ÷ 300	M12	160	2

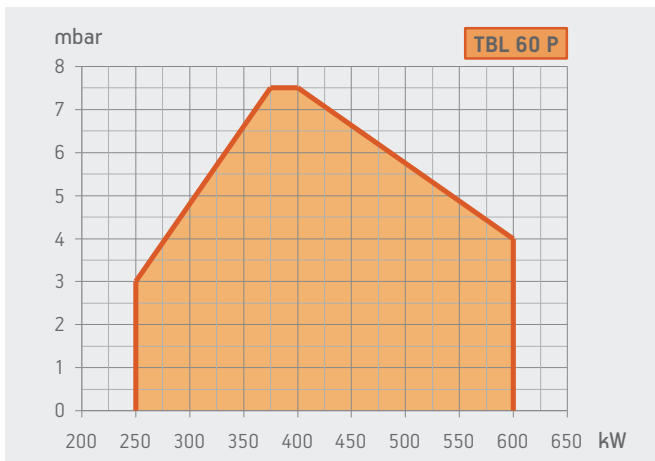

Model	Size of packaging			Weight kg
	L	P mm	H	
TBL 60 P	970	570	480	36
TBL 60 P DACA	970	570	480	36

	Emissions class	Thermal output kW	Model	Part no.	Max visc. °E at 20°C	Electrical supply	Motor kW	Notes
Frequency 50 Hz								
	class 2	250 ÷ 600	<b>TBL 60 P</b>	<b>35750010</b>	1,5	3N AC 50Hz 400V	0,65	
	class 2	250 ÷ 600	<b>TBL 60 P DACA</b>	<b>35750110</b>	1,5	3N AC 50Hz 400V	0,65	4)
Frequency 60 Hz								
	class 2	250 ÷ 600	<b>TBL 60 P</b>	<b>35755410</b>	1,5	3N AC 60Hz 380V	0,65	
	class 2	250 ÷ 600	<b>TBL 60 P DACA</b>	<b>35755420</b>	1,5	3N AC 60Hz 380V	0,65	4)

## OPTIONALS

DESCRIPTION
Biodiesel operation (5)

## ACCESSORIES AVAILABLE ON REQUEST

DESCRIPTION	PART NO.
Line filter 3/8"	98000370
Soundproof burner cover (see page 299)	97980054

## LIGHT OIL BURNER ACCESSORIES

Flex hoses, nozzles, boiler coupling kit, plug for wiring.

## NOTES

- 4 Equipped with air closure device.
- 5 Biodiesel according to european norm EN14213-FAME.  
Net calorific value of light oil: Hi = 42,70 MJ/kg = 10200 kcal/kg.



TBL 85 P



TBL 75 LX



BT 75 DSPG

### Light oil burner. Operation:

Continuous modulation operation by installing P.I.D. controller in the control panel (to be ordered separately with modulation probe).

Modulation ratio:

Low NOx and CO emissions light oil burner according to European standard EN267:

Adjusting the combustion head.

Maintenance facilitated by the possibility of removing the combustion head without having to remove the burner from the boiler.

High ventilation efficiency, low electrical input, low noise.

Sliding boiler coupling flange to adapt the blast-pipe to the various types of boilers.

Combustion air intake with butterfly valve. Air flow adjustment:

Fully closing air damper on shutdown to avoid loss of heat through the chimney.

Combustion air intake designed to achieve optimum linearity of the air gate opening.

Device made of sound-absorbing material to reduce fan noise.

Fuel supply circuit made of gear pump with pressure adjustment, shut-off valves and safety valve.

Fuel supply circuit made of gear pump with pressure adjustment and control flow valve.

Atomisation unit with magnet to control the outlet/nozzle return pins.

Flame detection by photoresistance.

Flame detection by IRD photocell.

Control panel with display diagram for working mode with indication lights.

Electric protection rating:

	TBL 85 P	TBL 85 P DACA	TBL 75 LX	BT 75 DSPG
	two-stage	two-stage	two-stage	mechanical two-stage progressive
Continuous modulation operation by installing P.I.D. controller in the control panel (to be ordered separately with modulation probe).				•
Modulation ratio:				1:2
Low NOx and CO emissions light oil burner according to European standard EN267:	class 2	class 2	class 3	
Adjusting the combustion head.	•	•	•	•
Maintenance facilitated by the possibility of removing the combustion head without having to remove the burner from the boiler.	•	•	•	•
High ventilation efficiency, low electrical input, low noise.	•	•		
Sliding boiler coupling flange to adapt the blast-pipe to the various types of boilers.	•	•	•	•
Combustion air intake with butterfly valve. Air flow adjustment:	hydraulic jack	electric servomotor	electric servomotor	mechanical cam
Fully closing air damper on shutdown to avoid loss of heat through the chimney.		•	•	•
Combustion air intake designed to achieve optimum linearity of the air gate opening.		•	•	
Device made of sound-absorbing material to reduce fan noise.		•	•	
Fuel supply circuit made of gear pump with pressure adjustment, shut-off valves and safety valve.	•	•	•	
Fuel supply circuit made of gear pump with pressure adjustment and control flow valve.				•
Atomisation unit with magnet to control the outlet/nozzle return pins.				•
Flame detection by photoresistance.	•	•		•
Flame detection by IRD photocell.			•	
Control panel with display diagram for working mode with indication lights.	•	•	•	
Electric protection rating:	IP40	IP40	IP44	IP40

LIGHT OIL

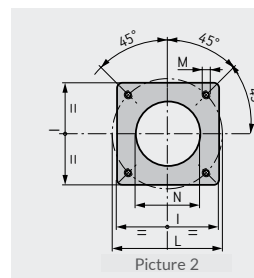
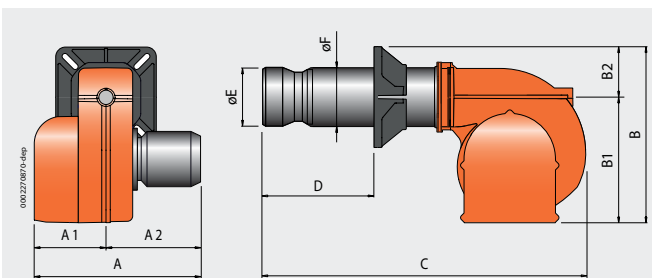

Flange dimensions and boiler drilling template.

Model	A mm	A1 mm	A2 mm	B mm	B1 mm	B2 mm	C mm	D mm	E mm	F mm	I mm	L mm	M mm	N mm	Pic.
TBL 85 P	670	300	370	510	380	130	1250	175 ÷ 400	161	159	260	225 ÷ 300	M12	170	2
TBL 85 P DACA	670	300	370	510	380	130	1250	175 ÷ 400	161	159	260	225 ÷ 300	M12	170	2
TBL 75 LX	670	300	370	510	380	130	1240	220 ÷ 400	152	159	260	225 ÷ 300	M12	170	2
BT 75 DSPG	595	310	385	510	365	145	1215	130 ÷ 450	205	160	260	255 ÷ 300	M12	170	2

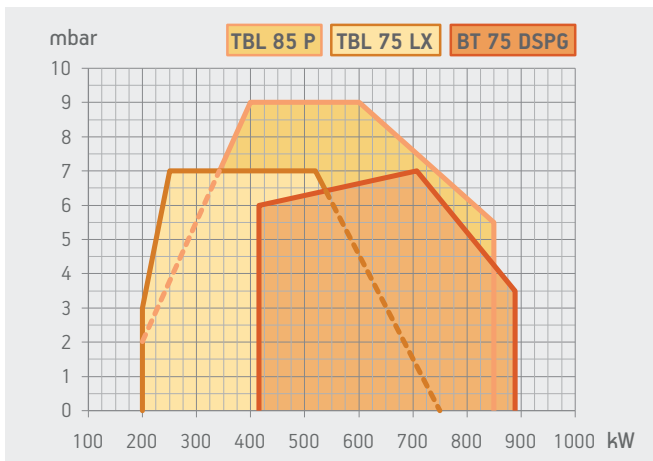

Model	Size of packaging			Weight kg
	L	P mm	H	
TBL 85 P	1070	800	700	79
TBL 85 P DACA	1070	800	700	79
TBL 75 LX	1070	800	700	82
BT 75 DSPG	1730	1030	880	140

	Emissions class	Thermal output kW	Model	Part no.	Max visc. °E at 20°C	Electrical supply	Motor kW	Notes
Frequency 50 Hz								
	class 2	200 ÷ 850	<b>TBL 85 P</b>	<b>35800010</b>	1,5	3N AC 50Hz 400V	1,10	15)
	class 2	200 ÷ 850	<b>TBL 85 P DACA</b>	<b>35800110</b>	1,5	3N AC 50Hz 400V	1,10	3) 4) 15)
	class 3	200 ÷ 750	<b>TBL 75 LX</b>	<b>35820010</b>	1,5	3N AC 50Hz 400V	1,10	3) 4) 15)
		415 ÷ 889	<b>BT 75 DSPG</b>	<b>3510010</b>	1,5	3N AC 50Hz 400V	1,10	4)
Frequency 60 Hz								
	class 2	200 ÷ 850	<b>TBL 85 P</b>	<b>35805410</b>	1,5	3N AC 60Hz 380V	1,10	15)
	class 2	200 ÷ 850	<b>TBL 85 P DACA</b>	<b>35805420</b>	1,5	3N AC 60Hz 380V	1,10	3) 4) 15)
		415 ÷ 889	<b>BT 75 DSPG</b>	<b>35105410</b>	1,5	3N AC 60Hz 380V	1,5+0,65	4)

## TO COMPLETE THE BURNER

### DESCRIPTION

BT 75 DSPG: nozzle with 1 ÷ 3 ratio (see page 295)

## MODULATING MODE

### DESCRIPTION

### PART NO.

BT 75 DSPG: modulation kit

98000055

BT 75 DSPG: modulating probe (see page 294)

## OPTIONALS

### DESCRIPTION

Biodiesel operation (5)

## ACCESSORIES AVAILABLE ON REQUEST

### DESCRIPTION

### PART NO.

TBL 85 P/85 P DACA - TBL 75 LX: soundproof burner cover (see page 299)

97980053

BT 75 DSPG: soundproof burner cover (see page 299)

97980055

## LIGHT OIL BURNER ACCESSORIES

TBL 85 P/85 P DACA - BT 75 LX: line filter, flex hoses, nozzles, boiler coupling kit, plug for wiring.

BT 75 DSPG: line filter, flex hoses, boiler coupling kit.

## NOTES

3 Soundproof lid on burner air intake.

4 Equipped with air closure device.

5 Biodiesel according to european norm EN14213-FAME.

15 Reference standard: EN267.

Net calorific value of light oil: Hi = 42,70 MJ/kg = 10200 kcal/kg.





TBL 105 P



BT 100 DSPG

### Light oil burner. Operation:

Continuous modulation operation by installing P.I.D. controller in the control panel (to be ordered separately with modulation probe).

Modulation ratio:

Low NOx and CO emissions light oil burner according to European standard EN267:

Adjusting the combustion head.

Maintenance facilitated by the possibility of removing the combustion head without having to remove the burner from the boiler.

High ventilation efficiency, low electrical input, low noise.

Sliding boiler coupling flange to adapt the blast-pipe to the various types of boilers.

Combustion air intake with butterfly valve. Air flow adjustment:

Fully closing air damper on shutdown to avoid loss of heat through the chimney.

Combustion air intake designed to achieve optimum linearity of the air gate opening.

Device made of sound-absorbing material to reduce fan noise.

Fuel supply circuit made of gear pump with pressure adjustment, shut-off valves and safety valve.

Fuel supply circuit made of gear pump with pressure adjustment and control flow valve.

Atomisation unit with magnet to control the outlet/nozzle return pins.

Flame detection by photoresistance.

Control panel with display diagram for working mode with indication lights.

Electric protection rating:

	TBL 105 P	TBL 105 P DACA	BT 100 DSPG
	two-stage	two-stage	mechanical two-stage progressive
Continuous modulation operation by installing P.I.D. controller in the control panel (to be ordered separately with modulation probe).			•
Modulation ratio:			1:2
Low NOx and CO emissions light oil burner according to European standard EN267:	class 2	class 2	
Adjusting the combustion head.	•	•	•
Maintenance facilitated by the possibility of removing the combustion head without having to remove the burner from the boiler.	•	•	•
High ventilation efficiency, low electrical input, low noise.	•	•	
Sliding boiler coupling flange to adapt the blast-pipe to the various types of boilers.	•	•	•
Combustion air intake with butterfly valve. Air flow adjustment:	hydraulic jack	electric servomotor	mechanical cam
Fully closing air damper on shutdown to avoid loss of heat through the chimney.		•	•
Combustion air intake designed to achieve optimum linearity of the air gate opening.	•	•	
Device made of sound-absorbing material to reduce fan noise.		•	
Fuel supply circuit made of gear pump with pressure adjustment, shut-off valves and safety valve.	•	•	
Fuel supply circuit made of gear pump with pressure adjustment and control flow valve.			•
Atomisation unit with magnet to control the outlet/nozzle return pins.			•
Flame detection by photoresistance.	•	•	•
Control panel with display diagram for working mode with indication lights.	•	•	
Electric protection rating:	IP40	IP40	IP40

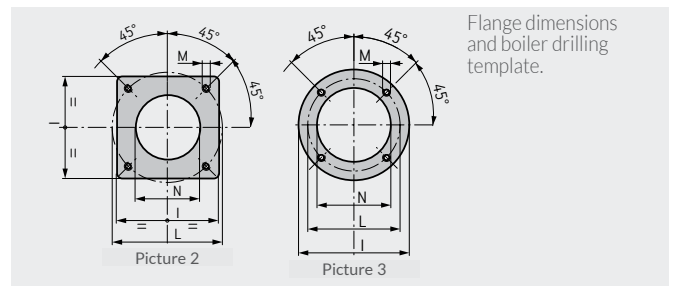
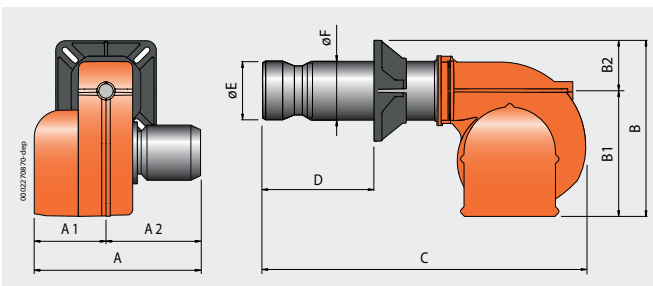

Model	A mm	A1 mm	A2 mm	B mm	B1 mm	B2 mm	C mm	D mm	E mm	F mm	I mm	L mm	M mm	N mm	Pic.
TBL 105 P	680	310	370	520	380	140	1250	175 ÷ 400	180	178	280	250 ÷ 325	M12	190	2
TBL 105 P DACA	680	310	370	520	380	140	1250	175 ÷ 400	180	178	280	250 ÷ 325	M12	190	2
BT 100 DSPG	670	330	340	525	365	160	1415	210 ÷ 400	230	195	320	276	M16	240	3

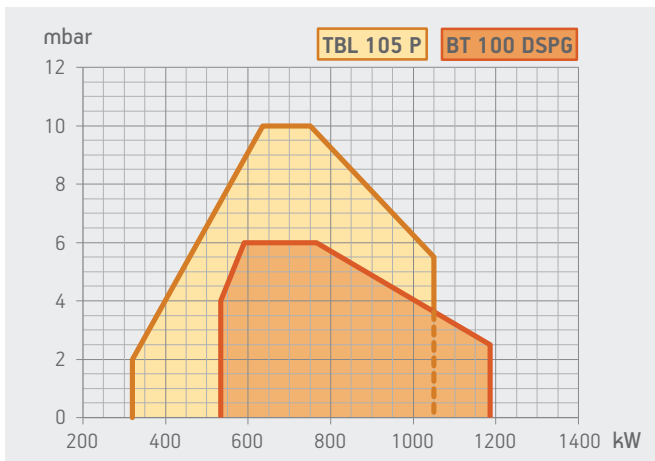

Model	Size of packaging			Weight kg
	L	P mm	H	
TBL 105 P	1070	800	700	80
TBL 105 P DACA	1070	800	700	80
BT 100 DSPG	1730	1030	880	150

	Emissions class	Thermal output kW	Model	Part no.	Max visc. °E at 20°C	Electrical supply	Motor kW	Notes
Frequency 50 Hz								
	class 2	320 ÷ 1050	<b>TBL 105 P</b>	<b>35850010</b>	1,5	3N AC 50Hz 400V	1,50	15)
	class 2	320 ÷ 1050	<b>TBL 105 P DACA</b>	<b>35850110</b>	1,5	3N AC 50Hz 400V	1,50	3) 4) 15)
		533 ÷ 1186	<b>BT 100 DSPG</b>	<b>3514010</b>	1,5	3N AC 50Hz 400V	1,50	4)
Frequency 60 Hz								
	class 2	320 ÷ 1050	<b>TBL 105 P</b>	<b>35855410</b>	1,5	3N AC 60Hz 380V	1,50	15)
	class 2	320 ÷ 1050	<b>TBL 105 P DACA</b>	<b>35855420</b>	1,5	3N AC 60Hz 380V	1,50	3) 4) 15)
		533 ÷ 1186	<b>BT 100 DSPG</b>	<b>35145410</b>	1,5	3N AC 60Hz 380V	2,60+0,65	4)

### TO COMPLETE THE BURNER

DESCRIPTION
BT 100 DSPG: nozzle with 1 ÷ 3 ratio (see page 295)

### MODULATING MODE

DESCRIPTION	PART NO.
BT 100 DSPG: modulation kit	98000055
BT 100 DSPG: modulating probe (see page 294)	

### OPTIONALS

DESCRIPTION
Biodiesel operation (5)

### NOTES

- 3 Soundproof lid on burner air intake.
  - 4 Equipped with air closure device.
  - 5 Biodiesel according to european norm EN14213-FAME.
  - 15 Reference standard: EN267.
- Net calorific value of light oil: Hi = 42,70 MJ/kg = 10200 kcal/kg.

### ACCESSORIES AVAILABLE ON REQUEST

DESCRIPTION	PART NO.
TBL 105 P/105 P DACA: soundproof burner cover (see page 299)	97980053
BT 100 DSPG: soundproof burner cover (see page 299)	97980055

### LIGHT OIL BURNER ACCESSORIES

TBL 105 P/105 P DACA: line filter, flex hoses, nozzles, boiler coupling kit, plug for wiring.
BT 100 DSPG: line filter, flex hoses, boiler coupling kit.



### Light oil burner. Operation:

Low NOx and CO emissions light oil burner according to European standard EN267:

Adjusting the combustion head.

Maintenance facilitated by the possibility of removing the combustion head without having to remove the burner from the boiler.

High ventilation efficiency, low electrical input, low noise.

Sliding boiler coupling flange to adapt the blast-pipe to the various types of boilers.

Combustion air intake with butterfly valve. Air flow adjustment:

Fully closing air damper on shutdown to avoid loss of heat through the chimney.

Combustion air intake designed to achieve optimum linearity of the air gate opening.

Device made of sound-absorbing material to reduce fan noise.

Fuel supply circuit made of gear pump with pressure adjustment, shut-off valves and safety valve.

Flame detection by photoresistance.

Control panel with display diagram for working mode with indication lights.

Electric protection rating:

	TBL 130 P	TBL 130 P DACA
	two-stage	two-stage
Low NOx and CO emissions light oil burner according to European standard EN267:	class 2	class 2
Adjusting the combustion head.	•	•
Maintenance facilitated by the possibility of removing the combustion head without having to remove the burner from the boiler.	•	•
High ventilation efficiency, low electrical input, low noise.	•	•
Sliding boiler coupling flange to adapt the blast-pipe to the various types of boilers.	•	•
Combustion air intake with butterfly valve. Air flow adjustment:	hydraulic jack	electric servomotor
Fully closing air damper on shutdown to avoid loss of heat through the chimney.		•
Combustion air intake designed to achieve optimum linearity of the air gate opening.	•	•
Device made of sound-absorbing material to reduce fan noise.		•
Fuel supply circuit made of gear pump with pressure adjustment, shut-off valves and safety valve.	•	•
Flame detection by photoresistance.	•	•
Control panel with display diagram for working mode with indication lights.	•	•
Electric protection rating:	IP40	IP40

LIGHT OIL

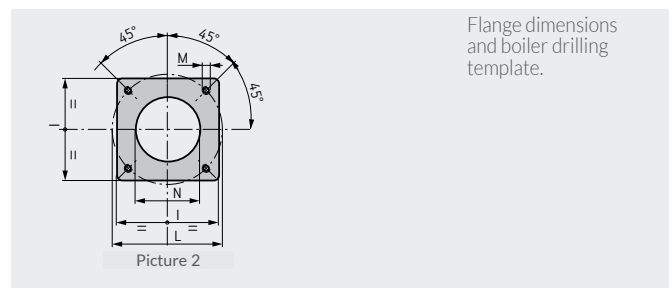
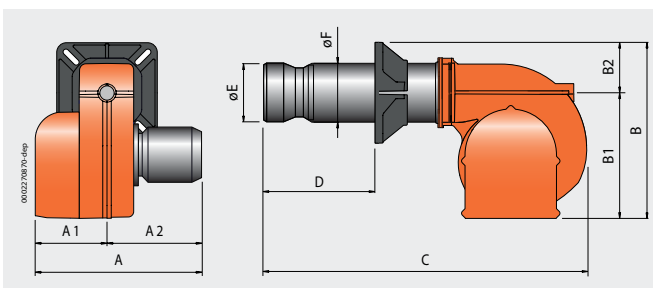

Model	A mm	A1 mm	A2 mm	B mm	B1 mm	B2 mm	C mm	D mm	E mm	F mm	I mm	L mm	M mm	N mm	Pic.
TBL 130 P	680	310	370	520	380	140	1250	175 ÷ 400	180	178	280	250 ÷ 325	M12	190	2
TBL 130 P DACA	680	310	370	520	380	140	1250	175 ÷ 400	180	178	280	250 ÷ 325	M12	190	2

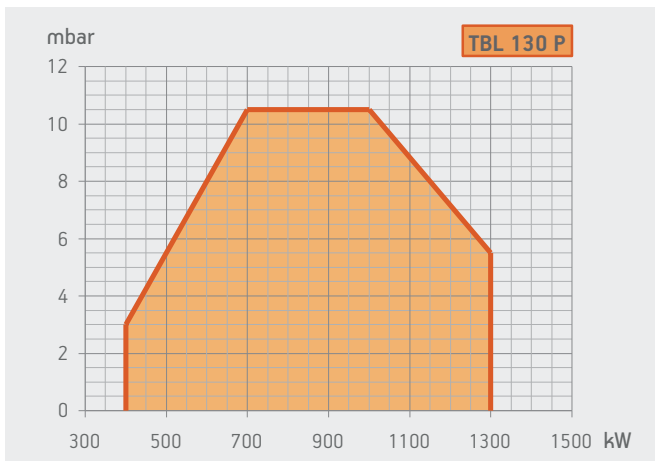

Model	Size of packaging			Weight kg
	L	P mm	H	
TBL 130 P	1070	800	700	85
TBL 130 P DACA	1070	800	700	85

	Emissions class	Thermal output kW	Model	Part no.	Max visc. °E at 20°C	Electrical supply	Motor kW	Notes
Frequency 50 Hz								
	class 2	400 ÷ 1300	<b>TBL 130 P</b>	<b>35900010</b>	1,5	3N AC 50Hz 400V	2,2	
	class 2	400 ÷ 1300	<b>TBL 130 P DACA</b>	<b>35900110</b>	1,5	3N AC 50Hz 400V	2,2	3) 4)
Frequency 60 Hz								
	class 2	400 ÷ 1300	<b>TBL 130 P</b>	<b>35905410</b>	1,5	3N AC 60Hz 380V	2,2	
	class 2	400 ÷ 1300	<b>TBL 130 P DACA</b>	<b>35905420</b>	1,5	3N AC 60Hz 380V	2,2	3) 4)

### OPTIONALS

DESCRIPTION
Biodiesel operation (5)

### ACCESSORIES AVAILABLE ON REQUEST

DESCRIPTION	PART NO.
Soundproof burner cover (see page 299)	97980053

### LIGHT OIL BURNER ACCESSORIES

Line filter, flex hoses, nozzles, boiler coupling kit, plug for wiring.

### NOTES

- 3 Soundproof lid on burner air intake.
- 4 Equipped with air closure device.
- 5 Biodiesel according to european norm EN14213-FAME.  
Net calorific value of light oil: Hi = 42,70 MJ/kg = 10200 kcal/kg.



TBL 160 P



BT 120 DSPG

### Light oil burner. Operation:

Continuous modulation operation by installing P.I.D. controller in the control panel (to be ordered separately with modulation probe).

Modulation ratio:

Low NOx and CO emissions light oil burner according to European standard EN267:

Adjusting the combustion head.

Maintenance facilitated by the possibility of removing the combustion head without having to remove the burner from the boiler.

High ventilation efficiency, low electrical input, low noise.

Sliding boiler coupling flange to adapt the blast-pipe to the various types of boilers.

Combustion air intake with butterfly valve. Air flow adjustment:

Fully closing air damper on shutdown to avoid loss of heat through the chimney.

Combustion air intake designed to achieve optimum linearity of the air gate opening.

Device made of sound-absorbing material to reduce fan noise.

Fuel supply circuit made of gear pump with pressure adjustment, shut-off valves and safety valve.

Fuel supply circuit made of gear pump with pressure adjustment and control flow valve.

Atomisation unit with magnet to control the outlet/nozzle return pins.

Flame detection by photoresistance.

Control panel with display diagram for working mode with indication lights.

Electric protection rating:

	TBL 160 P	TBL 160 P DACA	BT 120 DSPG
	two-stage	two-stage	mechanical two-stage progressive
Continuous modulation operation by installing P.I.D. controller in the control panel (to be ordered separately with modulation probe).			•
Modulation ratio:			1:3
Low NOx and CO emissions light oil burner according to European standard EN267:	class 2	class 2	
Adjusting the combustion head.	•	•	•
Maintenance facilitated by the possibility of removing the combustion head without having to remove the burner from the boiler.	•	•	•
High ventilation efficiency, low electrical input, low noise.	•	•	
Sliding boiler coupling flange to adapt the blast-pipe to the various types of boilers.	•	•	•
Combustion air intake with butterfly valve. Air flow adjustment:	hydraulic jack	electric servomotor	mechanical cam
Fully closing air damper on shutdown to avoid loss of heat through the chimney.		•	•
Combustion air intake designed to achieve optimum linearity of the air gate opening.	•	•	
Device made of sound-absorbing material to reduce fan noise.		•	
Fuel supply circuit made of gear pump with pressure adjustment, shut-off valves and safety valve.	•	•	
Fuel supply circuit made of gear pump with pressure adjustment and control flow valve.			•
Atomisation unit with magnet to control the outlet/nozzle return pins.			•
Flame detection by photoresistance.	•	•	•
Control panel with display diagram for working mode with indication lights.	•	•	
Electric protection rating:	IP40	IP40	IP40

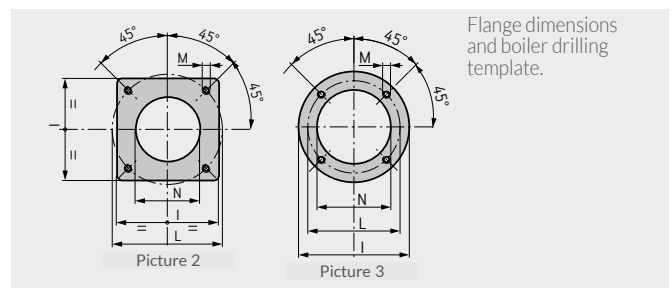
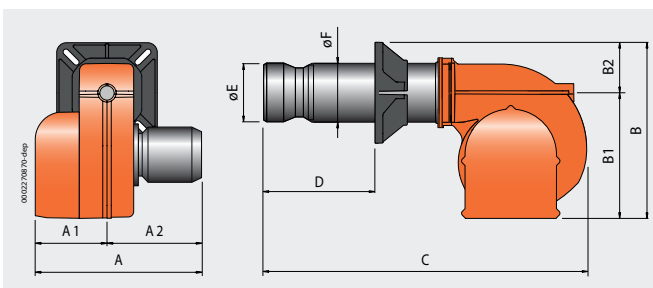

Model	A mm	A1 mm	A2 mm	B mm	B1 mm	B2 mm	C mm	D mm	E mm	F mm	I mm	L mm	M mm	N mm	Pic.
TBL 160 P	680	310	370	540	380	160	1300	200 ÷ 450	224	219	320	280 ÷ 370	M12	235	2
TBL 160 P DACA	680	310	370	540	380	160	1300	200 ÷ 450	224	219	320	280 ÷ 370	M12	235	2
BT 120 DSPG	770	390	380	610	450	160	1415	155 ÷ 500	230	195	320	276	M16	240	3

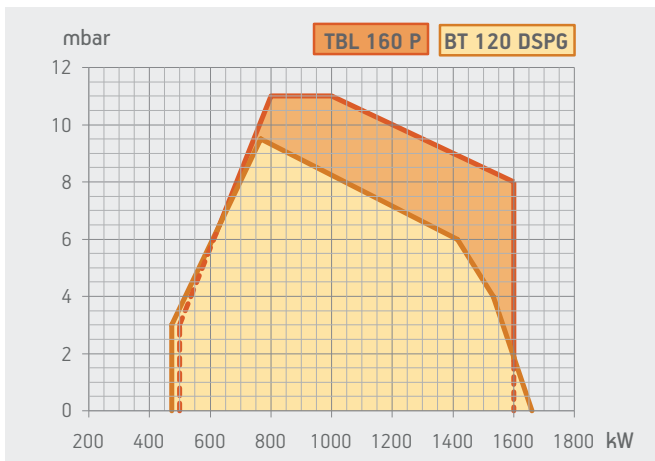

Model	Size of packaging			Weight kg
	L	P mm	H	
TBL 160 P	1070	800	700	90
TBL 160 P DACA	1070	800	700	90
BT 120 DSPG	1730	1030	880	175

	Emissions class	Thermal output kW	Model	Part no.	Max visc. °E at 20°C	Electrical supply	Motor kW	Notes
Frequency 50 Hz								
	class 2	500 ÷ 1600	<b>TBL 160 P</b>	<b>35950010</b>	1,5	3N AC 50Hz 400V	2,2	15)
	class 2	500 ÷ 1600	<b>TBL 160 P DACA</b>	<b>35950110</b>	1,5	3N AC 50Hz 400V	2,2	3) 4) 15)
		474 ÷ 1660	<b>BT 120 DSPG</b>	<b>3518010</b>	1,5	3N AC 50Hz 400V	2,2	4)
Frequency 60 Hz								
	class 2	500 ÷ 1600	<b>TBL 160 P</b>	<b>35955410</b>	1,5	3N AC 60Hz 380V	2,2	15)
	class 2	500 ÷ 1600	<b>TBL 160 P DACA</b>	<b>35955420</b>	1,5	3N AC 60Hz 380V	2,2	3) 4) 15)
		474 ÷ 1660	<b>BT 120 DSPG</b>	<b>35185410</b>	1,5	3N AC 60Hz 380V	3,5+1,3	4)

### TO COMPLETE THE BURNER

DESCRIPTION
BT 120 DSPG: nozzle with 1 ÷ 3 ratio (see page 295)

### MODULATING MODE

DESCRIPTION	PART NO.
BT 120 DSPG: modulation kit	98000055
BT 120 DSPG: modulating probe (see page 294)	

### OPTIONALS

DESCRIPTION
Biodiesel operation (5)

### NOTES

- 3 Soundproof lid on burner air intake.
  - 4 Equipped with air closure device.
  - 5 Biodiesel according to european norm EN14213-FAME.
  - 15 Reference standard: EN267.
- Net calorific value of light oil: Hi = 42,70 MJ/kg = 10200 kcal/kg.

### ACCESSORIES AVAILABLE ON REQUEST

DESCRIPTION	PART NO.
TBL 160 P/160 P DACA: soundproof burner cover (see page 299)	97980053
BT 120 DSPG: soundproof burner cover (see page 299)	97980055

### LIGHT OIL BURNER ACCESSORIES

- TBL 160 P/160 P DACA: line filter, flex hoses, nozzles, boiler coupling kit, plug for wiring.
- BT 120 DSPG: line filter, flex hoses, boiler coupling kit.



TBL 210 P



BT 180 DSPG

### Light oil burner. Operation:

Continuous modulation operation by installing P.I.D. controller in the control panel (to be ordered separately with modulation probe).

Modulation ratio:

Low NOx and CO emissions light oil burner according to European standard EN267:

Adjusting the combustion head.

Maintenance facilitated by the possibility of removing the combustion head without having to remove the burner from the boiler.

High ventilation efficiency, low electrical input, low noise.

Sliding boiler coupling flange to adapt the blast-pipe to the various types of boilers.

Combustion air intake with butterfly valve. Air flow adjustment:

Fully closing air damper on shutdown to avoid loss of heat through the chimney.

Combustion air intake designed to achieve optimum linearity of the air gate opening.

Device made of sound-absorbing material to reduce fan noise.

Fuel supply circuit made of gear pump with pressure adjustment, shut-off valves and safety valve.

Fuel supply circuit made of gear pump with pressure adjustment and control flow valve.

Atomisation unit with magnet to control the outlet/nozzle return pins.

Flame detection by photoresistance.

Control panel with display diagram for working mode with indication lights.

Electric protection rating:

	TBL 210 P	TBL 210 P DACA	BT 180 DSPG
	two-stage	two-stage	mechanical two-stage progressive
Continuous modulation operation by installing P.I.D. controller in the control panel (to be ordered separately with modulation probe).			•
Modulation ratio:			1:3
Low NOx and CO emissions light oil burner according to European standard EN267:	class 2	class 2	
Adjusting the combustion head.	•	•	•
Maintenance facilitated by the possibility of removing the combustion head without having to remove the burner from the boiler.	•	•	•
High ventilation efficiency, low electrical input, low noise.	•	•	
Sliding boiler coupling flange to adapt the blast-pipe to the various types of boilers.	•	•	•
Combustion air intake with butterfly valve. Air flow adjustment:	hydraulic jack	electric servomotor	mechanical cam
Fully closing air damper on shutdown to avoid loss of heat through the chimney.		•	•
Combustion air intake designed to achieve optimum linearity of the air gate opening.	•	•	
Device made of sound-absorbing material to reduce fan noise.		•	
Fuel supply circuit made of gear pump with pressure adjustment, shut-off valves and safety valve.	•	•	
Fuel supply circuit made of gear pump with pressure adjustment and control flow valve.			•
Atomisation unit with magnet to control the outlet/nozzle return pins.			•
Flame detection by photoresistance.	•	•	•
Control panel with display diagram for working mode with indication lights.	•	•	
Electric protection rating:	IP40	IP40	IP40

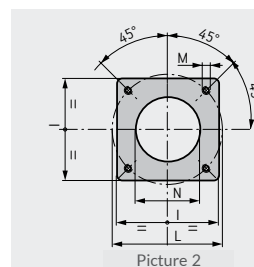
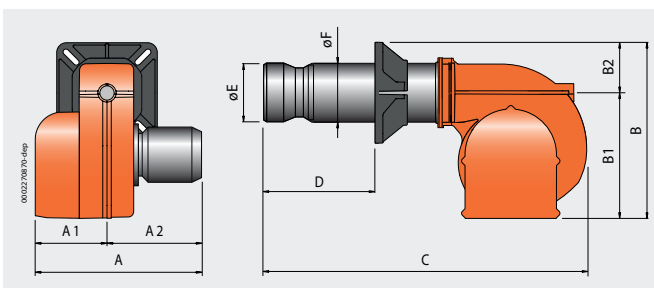

Flange dimensions and boiler drilling template.

Model	A mm	A1 mm	A2 mm	B mm	B1 mm	B2 mm	C mm	D mm	E mm	F mm	I mm	L mm	M mm	N mm	Pic.
TBL 210 P	680	310	370	540	380	160	1300	210 ÷ 450	250	219	320	280 ÷ 370	M12	255	2
TBL 210 P DACA	680	310	370	540	380	160	1300	210 ÷ 450	250	219	320	280 ÷ 370	M12	255	2
BT 180 DSPG	815	390	425	650	450	200	1700	200 ÷ 535	260	220	320	280 ÷ 370	M12	230	2

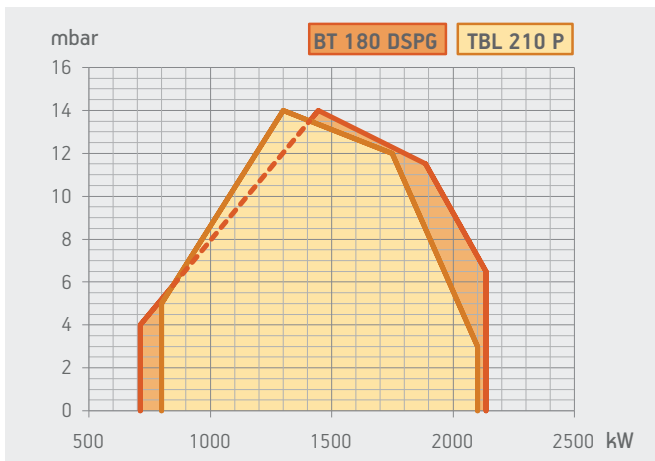

Model	Size of packaging			Weight kg
	L	P mm	H	
TBL 210 P	1070	800	700	94
TBL 210 P DACA	1070	800	700	94
BT 180 DSPG	1730	1030	880	220

	Emissions class	Thermal output kW	Model	Part no.	Max visc. °E at 20°C	Electrical supply	Motor kW	Notes
Frequency 50 Hz								
	class 2	800 ÷ 2100	<b>TBL 210 P</b>	<b>36000020</b>	1,5	3N AC 50Hz 400V	3,0	15)
	class 2	800 ÷ 2100	<b>TBL 210 P DACA</b>	<b>36000010</b>	1,5	3N AC 50Hz 400V	3,0	3) 4) 15)
		712 ÷ 2135	<b>BT 180 DSPG</b>	<b>3522010</b>	1,5	3N AC 50Hz 400V	3,0	4)
Frequency 60 Hz								
	class 2	800 ÷ 2100	<b>TBL 210 P</b>	<b>36005420</b>	1,5	3N AC 60Hz 380V	3,0	15)
	class 2	800 ÷ 2100	<b>TBL 210 P DACA</b>	<b>36005410</b>	1,5	3N AC 60Hz 380V	3,0	3) 4) 15)
		712 ÷ 2135	<b>BT 180 DSPG</b>	<b>35225410</b>	1,5	3N AC 60Hz 380V	3,5+1,3	4)

### TO COMPLETE THE BURNER

DESCRIPTION
BT 180 DSPG: nozzle with 1 ÷ 3 ratio (see page 295)

### MODULATING MODE

DESCRIPTION	PART NO.
BT 180 DSPG: modulation kit	98000055
BT 180 DSPG: modulating probe (see page 294)	

### OPTIONALS

DESCRIPTION
Biodiesel operation (5)

### NOTES

- Soundproof lid on burner air intake.
- Equipped with air closure device.
- Biodiesel according to european norm EN14213-FAME.
- Reference standard: EN267.
- Net calorific value of light oil: Hi = 42,70 MJ/kg = 10200 kcal/kg.

### ACCESSORIES AVAILABLE ON REQUEST

DESCRIPTION	PART NO.
TBL 210 P/210 P DACA : soundproof burner cover (see page 299)	97980053
BT 180 DSPG: soundproof burner cover (see page 299)	97980057

### LIGHT OIL BURNER ACCESSORIES

TBL 210 P/210 P DACA: line filter, flex hoses, nozzles, boiler coupling kit, plug for wiring.
BT 180 DSPG: line filter, flex hoses, boiler coupling kit.





TBL 260 P



BT 250 DSPG

**Light oil burner. Operation:**

Continuous modulation operation by installing P.I.D. controller in the control panel (to be ordered separately with modulation probe).

Modulation ratio:

Low NOx and CO emissions light oil burner according to European standard EN267:

Adjusting the combustion head.

Maintenance facilitated by the possibility of removing the combustion head without having to remove the burner from the boiler.

High ventilation efficiency, low electrical input, low noise.

Sliding boiler coupling flange to adapt the blast-pipe to the various types of boilers.

Combustion air intake with butterfly valve. Air flow adjustment:

Fully closing air damper on shutdown to avoid loss of heat through the chimney.

Fuel supply circuit made of gear pump with pressure adjustment, shut-off valves and safety valve.

Fuel supply circuit made of gear pump with pressure adjustment and control flow valve.

Atomisation unit with magnet to control the outlet/nozzle return pins.

Flame detection by photoresistance.

Control panel with display diagram for working mode with indication lights.

Electric protection rating:

	TBL 260 P	TBL 260 P DACA	BT 250 DSPG
	two-stage	two-stage	mechanical two-stage progressive
Continuous modulation operation by installing P.I.D. controller in the control panel (to be ordered separately with modulation probe).			•
Modulation ratio:			1:3
Low NOx and CO emissions light oil burner according to European standard EN267:	class 2	class 2	
Adjusting the combustion head.	•	•	•
Maintenance facilitated by the possibility of removing the combustion head without having to remove the burner from the boiler.	•	•	•
High ventilation efficiency, low electrical input, low noise.	•	•	
Sliding boiler coupling flange to adapt the blast-pipe to the various types of boilers.	•	•	•
Combustion air intake with butterfly valve. Air flow adjustment:	hydraulic jack	electric servomotor	mechanical cam
Fully closing air damper on shutdown to avoid loss of heat through the chimney.		•	•
Fuel supply circuit made of gear pump with pressure adjustment, shut-off valves and safety valve.	•	•	
Fuel supply circuit made of gear pump with pressure adjustment and control flow valve.			•
Atomisation unit with magnet to control the outlet/nozzle return pins.			•
Flame detection by photoresistance.	•	•	•
Control panel with display diagram for working mode with indication lights.	•	•	
Electric protection rating:	IP40	IP40	IP40

LIGHT OIL

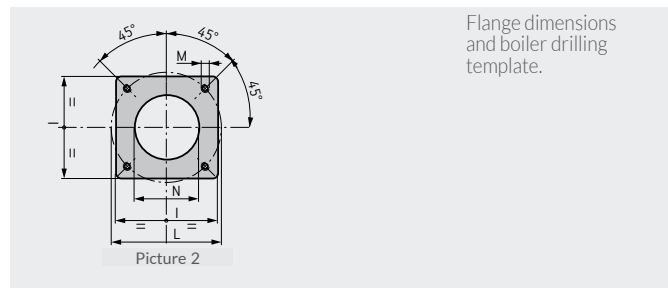
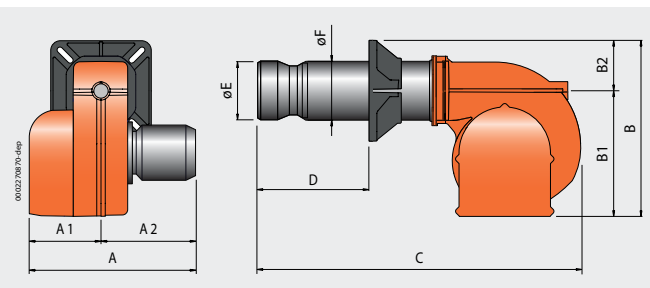

Model	A mm	A1 mm	A2 mm	B mm	B1 mm	B2 mm	C mm	D mm	E mm	F mm	I mm	L mm	M mm	N mm	Pic.
TBL 260 P	760	340	420	560	400	160	1300	210 ÷ 450	250	219	320	280 ÷ 370	M12	255	2
TBL 260 P DACA	760	340	420	560	400	160	1300	210 ÷ 450	250	219	320	280 ÷ 370	M12	255	2
BT 250 DSPG	1000	520	480	740	580	160	1700	235 ÷ 560	260	220	320	280 ÷ 370	M12	230	2

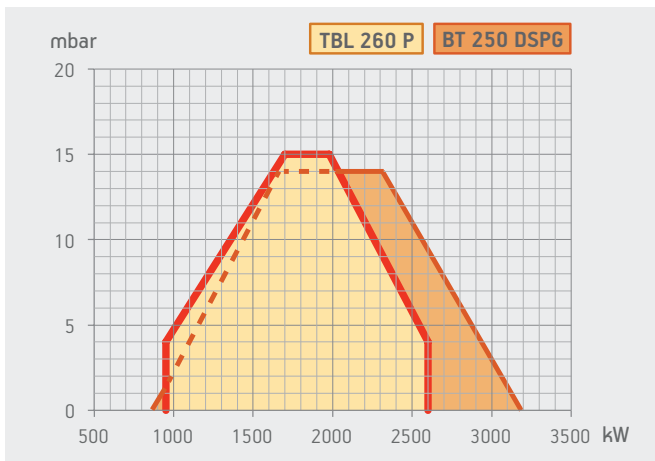

Model	Size of packaging			Weight kg
	L	P mm	H	
TBL 260 P	1070	870	720	105
TBL 260 P DACA	1070	870	720	105
BT 250 DSPG	1030	1150	1010	256

	Emissions class	Thermal output kW	Model	Part no.	Max visc. °E at 20°C	Electrical supply	Motor kW	Notes
Frequency 50 Hz								
	class 2	950 ÷ 2600	<b>TBL 260 P</b>	<b>36040020</b>	1,5	3N AC 50Hz 400V	5,5	15)
	class 2	950 ÷ 2600	<b>TBL 260 P DACA</b>	<b>36040010</b>	1,5	3N AC 50Hz 400V	5,5	4) 15)
		873 ÷ 3186	<b>BT 250 DSPG</b>	<b>3526010</b>	1,5	3N AC 50Hz 400V	7,5	4)
Frequency 60 Hz								
	class 2	950 ÷ 2600	<b>TBL 260 P</b>	<b>36045420</b>	1,5	3N AC 60Hz 380V	7,5	15)
	class 2	950 ÷ 2600	<b>TBL 260 P DACA</b>	<b>36045410</b>	1,5	3N AC 60Hz 380V	7,5	4) 15)
		873 ÷ 3186	<b>BT 250 DSPG</b>	<b>35265410</b>	1,5	3N AC 60Hz 380V	9,0+1,3	4)

### TO COMPLETE THE BURNER

DESCRIPTION
BT 250 DSPG: nozzle with 1 ÷ 3 ratio (see page 295)

### MODULATING MODE

DESCRIPTION	PART NO.
BT 250 DSPG: modulation kit	98000055
BT 250 DSPG: modulating probe (see page 294)	

### OPTIONALS

DESCRIPTION
Biodiesel operation (5)

### NOTES

- 4 Equipped with air closure device.
  - 5 Biodiesel according to european norm EN14213-FAME.
  - 15 Reference standard: EN267.
- Net calorific value of light oil: Hi = 42,70 MJ/kg = 10200 kcal/kg.

### ACCESSORIES AVAILABLE ON REQUEST

DESCRIPTION	PART NO.
TBL 260 P/260 P DACA: soundproof burner cover (see page 299)	97980053
BT 250 DSPG: soundproof burner cover (see page 299)	97980057

### LIGHT OIL BURNER ACCESSORIES

- TBL 260 P/260 P DACA: line filter, flex hoses, nozzles, boiler coupling kit, plug for wiring.
- BT 250 DSPG: line filter, flex hoses, boiler coupling kit.



BT 300 DSG 4T



BT 300 DSG 4T HINGED



BT 300 DSPG

	BT 300 DSG 4T	BT 300 DSG 4T Hinged	BT 300 DSPG
<b>Light oil burner. Operation:</b>	two-stage	two-stage	mechanical two-stage progressive
Continuous modulation operation by installing P.I.D. controller in the control panel (to be ordered separately with modulation probe).			•
Modulation ratio:			1:3
Adjusting the combustion head.	•	•	•
Maintenance facilitated by the possibility of removing the combustion head without having to remove the burner from the boiler.	•	•	•
Fixed boiler coupling flange.		•	
Sliding boiler coupling flange to adapt the blast-pipe to the various types of boilers.	•		•
Easy maintenance thanks to the two-sides hinge which allows the removal of the combustion head without having to remove the burner from the boiler.		•	
Combustion air intake with butterfly valve. Air flow adjustment:	electric servomotor	electric servomotor	mechanical cam
Fully closing air damper on shutdown to avoid loss of heat through the chimney.	•	•	•
Fuel supply circuit made of gear pump with pressure adjustment, shut-off valves and safety valve.	•	•	
Fuel supply circuit made of gear pump with pressure adjustment and control flow valve.			•
Atomisation unit with nozzle-closing pin.	•	•	
Atomisation unit with magnet to control the outlet/nozzle return pins.			•
Flame detection by photoresistance.	•	•	•
Control panel with display diagram for working mode with indication lights.	•	•	
Electric protection rating:	IP40	IP40	IP40

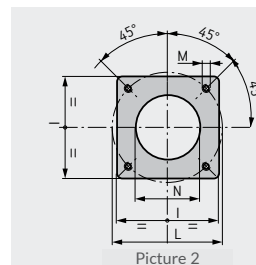
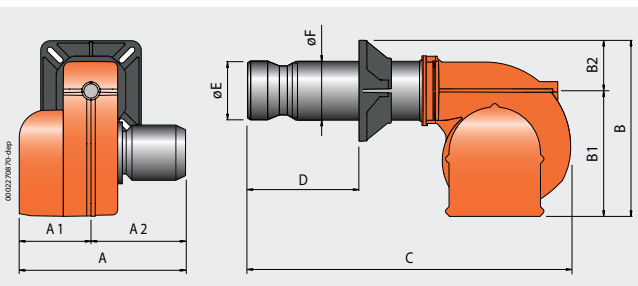

Flange dimensions and boiler drilling template.

Model	A mm	A1 mm	A2 mm	B mm	B1 mm	B2 mm	C mm	D mm	E mm	F mm	I mm	L mm	M mm	N mm	Pic.
BT 300 DSG 4T	915	435	480	800	580	220	1700	245 ÷ 605	360	275	440	400 ÷ 540	M20	365	2
BT 300 DSG 4T Hinged	915	435	480	800	580	220	1350	420	360	280	430	509	M18	370	2
BT 300 DSPG	1000	520	480	800	580	220	1900	245 ÷ 605	360	275	440	400 ÷ 540	M20	365	2

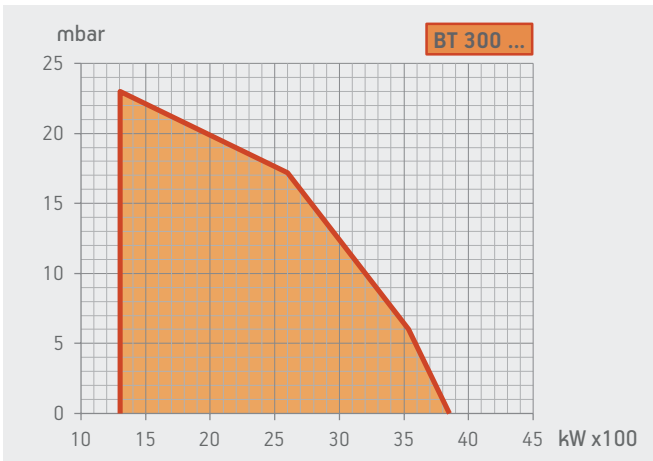

Model	Size of packaging			Weight kg
	L	P mm	H	
BT 300 DSG 4T	2030	1150	1010	265
BT 300 DSG 4T Hinged	1730	1030	880	265
BT 300 DSPG	2030	1150	1010	290

	Thermal output kW	Model	Part no.	Max visc. °E at 20°C	Electrical supply	Motor kW	Notes
Frequency 50 Hz							
1304 ÷ 3854		<b>BT 300 DSG 4T</b>	<b>31510010</b>	1,5	3N AC 50Hz 400V	7,5	4)
1304 ÷ 3854		<b>BT 300 DSG 4T Hinged</b>	<b>31510011</b>	1,5	3N AC 50Hz 400V	7,5	4)
1304 ÷ 3854		<b>BT 300 DSPG</b>	<b>3530010</b>	1,5	3N AC 50Hz 400V	7,5	4)
Frequency 60 Hz							
1304 ÷ 3854		<b>BT 300 DSG 4T</b>	<b>31515410</b>	1,5	3N AC 60Hz 380V	9,0+1,3	4)
1304 ÷ 3854		<b>BT 300 DSG 4T Hinged</b>	<b>31515411</b>	1,5	3N AC 60Hz 380V	9,0+1,3	4)
1304 ÷ 3854		<b>BT 300 DSPG</b>	<b>35305410</b>	1,5	3N AC 60Hz 380V	9,0+1,3	4)

### TO COMPLETE THE BURNER

#### DESCRIPTION

BT 300 DSPG: nozzle with 1 ÷ 3 ratio (see page 295)

### MODULATING MODE

#### DESCRIPTION

BT 300 DSPG: modulation kit

#### PART NO.

98000055

BT 300 DSPG: modulating probe (see page 294)

### OPTIONALS

#### DESCRIPTION

Biodiesel operation (5)

### ACCESSORIES AVAILABLE ON REQUEST

#### DESCRIPTION

Soundproof burner cover (see page 299)

#### PART NO.

97980057

### LIGHT OIL BURNER ACCESSORIES

BT 300 DSG 4T: line filter, flex hoses, nozzles, boiler coupling kit, plug for wiring.

BT 300 DSPG: line filter, flex hoses, boiler coupling kit.

### NOTES

4 Equipped with air closure device.

5 Biodiesel according to european norm EN14213-FAME.

Net calorific value of light oil: Hi = 42,70 MJ/kg = 10200 kcal/kg.



BT 350 DSG



BT 350 DSG HINGED

### Light oil burner. Operation:

Adjusting the combustion head.

Maintenance facilitated by the possibility of removing the combustion head without having to remove the burner from the boiler.

Fixed boiler coupling flange.

Sliding boiler coupling flange to adapt the blast-pipe to the various types of boilers.

Easy maintenance thanks to the two-sides hinge which allows the removal of the combustion head without having to remove the burner from the boiler.

Combustion air intake with butterfly valve. Air flow adjustment:

Fully closing air damper on shutdown to avoid loss of heat through the chimney.

Fuel supply circuit made of gear pump with pressure adjustment, shut-off valves and safety valve.

Atomisation unit with nozzle-closing pin.

Flame detection by photoresistance.

Electric protection rating:

	BT 350 DSG	BT 350 DSG Hinged
	two-stage	two-stage
Adjusting the combustion head.	•	•
Maintenance facilitated by the possibility of removing the combustion head without having to remove the burner from the boiler.	•	•
Fixed boiler coupling flange.		•
Sliding boiler coupling flange to adapt the blast-pipe to the various types of boilers.	•	
Easy maintenance thanks to the two-sides hinge which allows the removal of the combustion head without having to remove the burner from the boiler.		•
Combustion air intake with butterfly valve. Air flow adjustment:	electric servomotor	electric servomotor
Fully closing air damper on shutdown to avoid loss of heat through the chimney.	•	•
Fuel supply circuit made of gear pump with pressure adjustment, shut-off valves and safety valve.	•	•
Atomisation unit with nozzle-closing pin.	•	•
Flame detection by photoresistance.	•	•
Electric protection rating:	IP40	IP40

LIGHT OIL

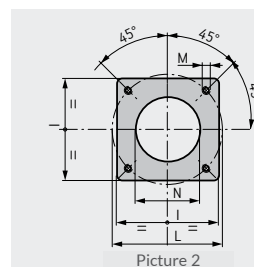
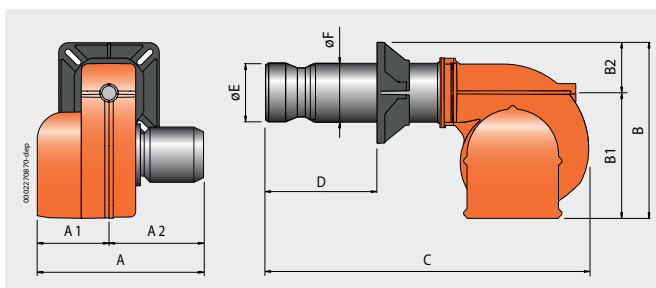

Flange dimensions and boiler drilling template.

Model	A mm	A1 mm	A2 mm	B mm	B1 mm	B2 mm	C mm	D mm	E mm	F mm	I mm	L mm	M mm	N mm	Pic.
BT 350 DSG 4T	1050	525	525	880	660	220	1960	350 ÷ 560	360	275	440	400 ÷ 540	M20	365	2
BT 350 DSG Hinged	1050	525	525	880	660	220	1440	420	360	280	430	509	M18	370	2

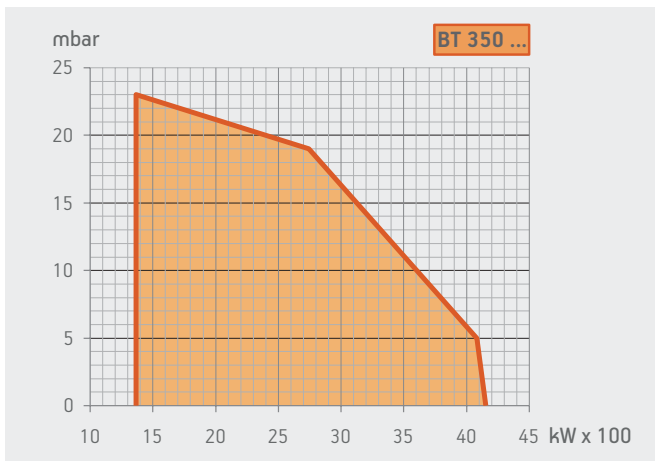

Model	Size of packaging			Weight kg
	L	P mm	H	
BT 350 DSG	2030	1150	1010	310
BT 350 DSG Hinged	1670	1530	1300	310

	Thermal output kW	Model	Part no.	Max visc. °E at 20°C	Electrical supply	Motor kW	Notes
Frequency 50 Hz							
1364 ÷ 4151		<b>BT 350 DSG</b>	<b>3140010</b>	1,5	3N AC 50Hz 400V	9,0	4)
1364 ÷ 4151		<b>BT 350 DSG Hinged</b>	<b>3140011</b>	1,5	3N AC 50Hz 400V	9,0	4)
Frequency 60 Hz							
1364 ÷ 4151		<b>BT 350 DSG</b>	<b>31405410</b>	1,5	3N AC 60Hz 380V	11,0+1,3	4)
1364 ÷ 4151		<b>BT 350 DSG Hinged</b>	<b>31405411</b>	1,5	3N AC 60Hz 380V	11,0+1,3	4)

### ACCESSORIES AVAILABLE ON REQUEST

DESCRIPTION	PART NO.
Soundproof burner cover (see page 299)	97980057

### LIGHT OIL BURNER ACCESSORIES

Line filter, flex hoses, nozzles, boiler coupling kit.

### NOTES

4) Equipped with air closure device.  
Net calorific value of light oil: Hi = 42,70 MJ/kg = 10200 kcal/kg.



### Light oil burner. Operation:

Continuous modulation operation by installing P.I.D. controller in the control panel (to be ordered separately with modulation probe).

Modulation ratio:

Adjusting the combustion head.

Maintenance facilitated by the possibility of removing the combustion head without having to remove the burner from the boiler.

Sliding boiler coupling flange to adapt the blast-pipe to the various types of boilers.

Combustion air intake with butterfly valve. Air flow adjustment:

Fully closing air damper on shutdown to avoid loss of heat through the chimney.

Electric motor for pump drive.

Fuel supply circuit made of gear pump with pressure adjustment and control flow valve.

Atomisation unit with magnet to control the outlet/nozzle return pins.

Flame detection by photoresistance.

Electric protection rating:

	GI 350 DSPG	GI 420 DSPG	GI 510 DSPG
	mechanical two-stage progressive	mechanical two-stage progressive	mechanical two-stage progressive
	•	•	•
Modulation ratio:	1:3	1:3	1:3
Adjusting the combustion head.	•	•	•
Maintenance facilitated by the possibility of removing the combustion head without having to remove the burner from the boiler.	•	•	•
Sliding boiler coupling flange to adapt the blast-pipe to the various types of boilers.	•	•	•
Combustion air intake with butterfly valve. Air flow adjustment:	mechanical cam	mechanical cam	mechanical cam
Fully closing air damper on shutdown to avoid loss of heat through the chimney.	•	•	•
Electric motor for pump drive.	•	•	•
Fuel supply circuit made of gear pump with pressure adjustment and control flow valve.	•	•	•
Atomisation unit with magnet to control the outlet/nozzle return pins.	•	•	•
Flame detection by photoresistance.	•	•	•
Electric protection rating:	IP40	IP40	IP40

LIGHT OIL

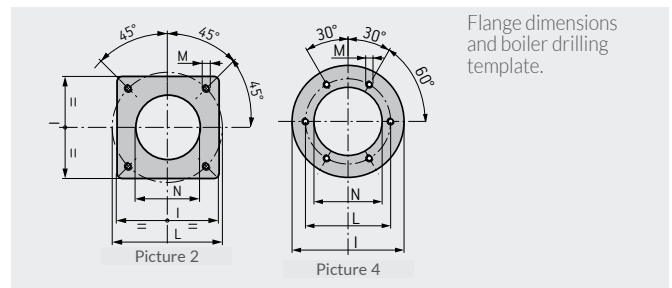
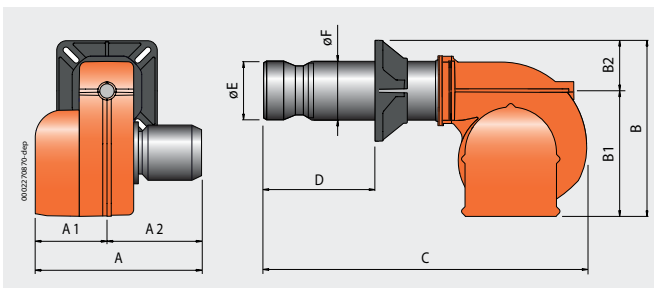

Model	A mm	A1 mm	A2 mm	B mm	B1 mm	B2 mm	C mm	D mm	E mm	F mm	I mm	L mm	M mm	N mm	Pic.
GI 350 DSPG	1345	660	685	970	750	220	1900	275 ÷ 500	360	275	440	400 ÷ 540	M20	365	2
GI 420 DSPG	1345	660	685	1040	750	290	2030	275 ÷ 560	400	355	580	520	M20	420	4
GI 510 DSPG	1345	660	685	1040	750	290	2030	275 ÷ 560	400	355	580	520	M20	420	4

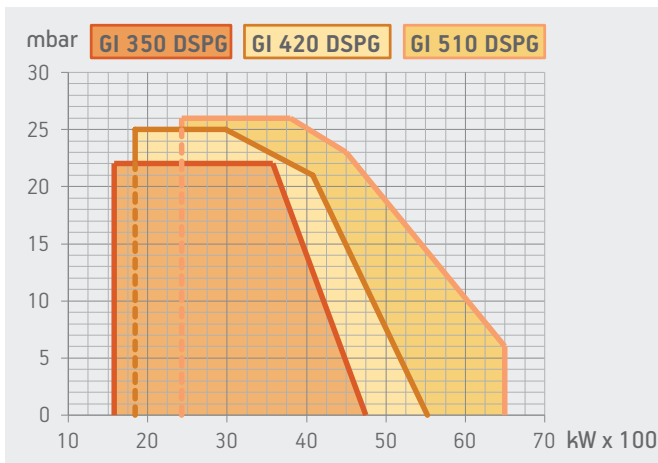

Model	Size of packaging			Weight kg
	L	P mm	H	
GI 350 DSPG	2260	1520	1150	500
GI 420 DSPG	2260	1520	1150	540
GI 510 DSPG	2260	1520	1150	580

	Thermal output kW	Model	Part no.	Max visc. °E at 20°C	Electrical supply	Motor kW	Notes
Frequency 50 Hz							
	1581 ÷ 4743	<b>GI 350 DSPG</b>	<b>6501010</b>	1,5	3N AC 50Hz 400V	15,0+2,2	4)
	1840 ÷ 5522	<b>GI 420 DSPG</b>	<b>6506010</b>	1,5	3N AC 50Hz 400V	18,5+2,2	4)
	2430 ÷ 6500	<b>GI 510 DSPG</b>	<b>6511010</b>	1,5	3N AC 50Hz 400V	18,5+3,0	4)
Frequency 60 Hz							
	1581 ÷ 4743	<b>GI 350 DSPG</b>	<b>65015410</b>	1,5	3N AC 60Hz 380V	11,0+2,6	4)
	1840 ÷ 5522	<b>GI 420 DSPG</b>	<b>65065410</b>	1,5	3N AC 60Hz 380V	13,0+2,6	4)
	2430 ÷ 6500	<b>GI 510 DSPG</b>	<b>65115410</b>	1,5	3N AC 60Hz 380V	22,0+3,5	4)

## TO COMPLETE THE BURNER

### DESCRIPTION

Nozzle with 1 ÷ 3 ratio (see page 295)

## MODULATION MODE

### DESCRIPTION

### PART NO.

Modulation kit

98000055

Modulating probe (see page 294)

## LIGHT OIL BURNER ACCESSORIES

Line filter, flex hoses, boiler coupling kit.

## NOTES

4) Equipped with air closure device.

Net calorific value of light oil: Hi = 42,70 MJ/kg = 10200 kcal/kg.





## GI 1000 DSPG

### Light oil burner. Operation:

### mechanical two-stage progressive

Continuous modulation operation by installing P.I.D. controller in the control panel (to be ordered separately with modulation probe).

•

Modulation ratio:

1:4

Adjusting the combustion head.

•

Maintenance facilitated by the possibility of removing the combustion head without having to remove the burner from the boiler.

•

Fixed boiler coupling flange.

•

Easy maintenance thanks to the two-sides hinge which allows the removal of the combustion head without having to remove the burner from the boiler.

•

Combustion air intake with butterfly valve. Air flow adjustment:

mechanical cam

Fully closing air damper on shutdown to avoid loss of heat through the chimney.

•

Electric motor for pump drive.

•

Fuel supply circuit made of gear pump with pressure adjustment and control flow valve.

•

Atomisation unit with magnet to control the outlet/nozzle return pins.

•

Flame detection by photoresistance.

•

Electric protection rating:

IP40

LIGHT OIL

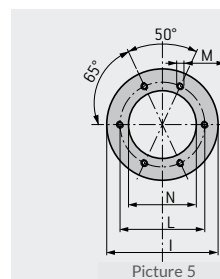
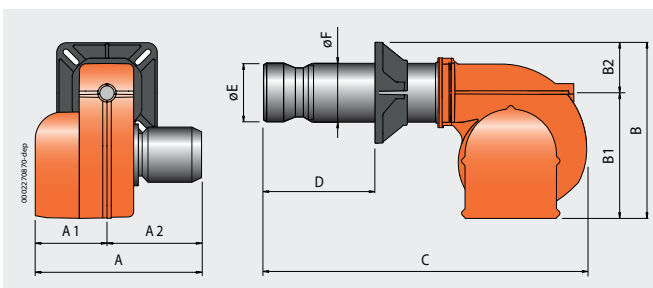

Flange dimensions and boiler drilling template.

Picture 5

Model	A mm	A1 mm	A2 mm	B mm	B1 mm	B2 mm	C mm	D mm	E mm	F mm	I mm	L mm	M mm	N mm	Pic.
GI 1000 DSPG	1465	800	665	1260	855	405	1960	430	480	490	800	765	M16	495	5

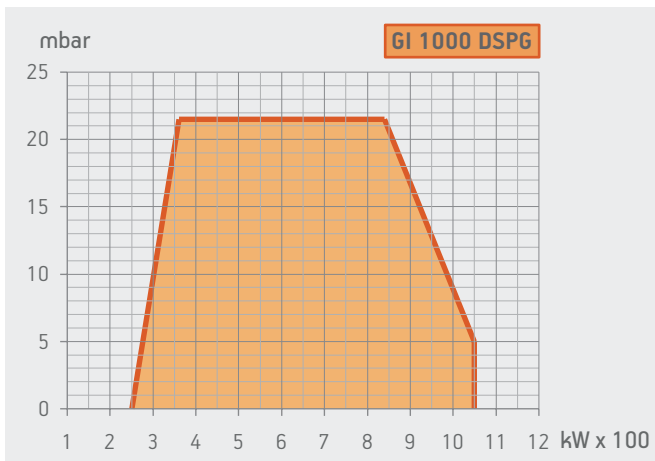

Model	Size of packaging			Weight kg
	L	P mm	H	
GI 1000 DSPG	2610	1760	1470	900

	Thermal output kW	Model	Part no.	Max visc. °E at 20°C	Electrical supply	Motor kW	Notes
		Frequency 50 Hz					
	2500 ÷ 10500	<b>GI 1000 DSPG</b>	<b>6521010</b>	1,5	3N AC 50Hz 400V	22,0+4,0	4)
		Frequency 60 Hz					
	2500 ÷ 10500	<b>GI 1000 DSPG</b>	<b>65215410</b>	1,5	3N AC 60Hz 380V	30,0+3,5	4)

### TO COMPLETE THE BURNER

#### DESCRIPTION

Nozzle with 1 ÷ 5 ratio (see page 295)

### MODULATING MODE

#### DESCRIPTION

Modulation kit

#### PART NO.

98000055

Modulating probe (see page 294)

### LIGHT OIL BURNER ACCESSORIES

Line filter, flex hoses, boiler coupling kit.

### NOTES

4) Equipped with air closure device.

Net calorific value of light oil: Hi = 42,70 MJ/kg = 10200 kcal/kg.

## Symbology

**BT 17 N**  
Single-stage  
heavy oil burner.

**BT...SPN**  
Two-stage  
pressure  
drop heavy oil  
burners.

**BT...DSN 4T**  
Two-stage  
heavy oil  
burners.

**BT...DSNM-D**  
Two-stage  
extra heavy oil  
burners.

**BT...DSPN**  
Two-stage  
progressive/  
modulating  
heavy oil  
burners with  
mechanical cam.

## SINGLE-STAGE HEAVY OIL BURNERS



## TWO-STAGE HEAVY OIL BURNERS

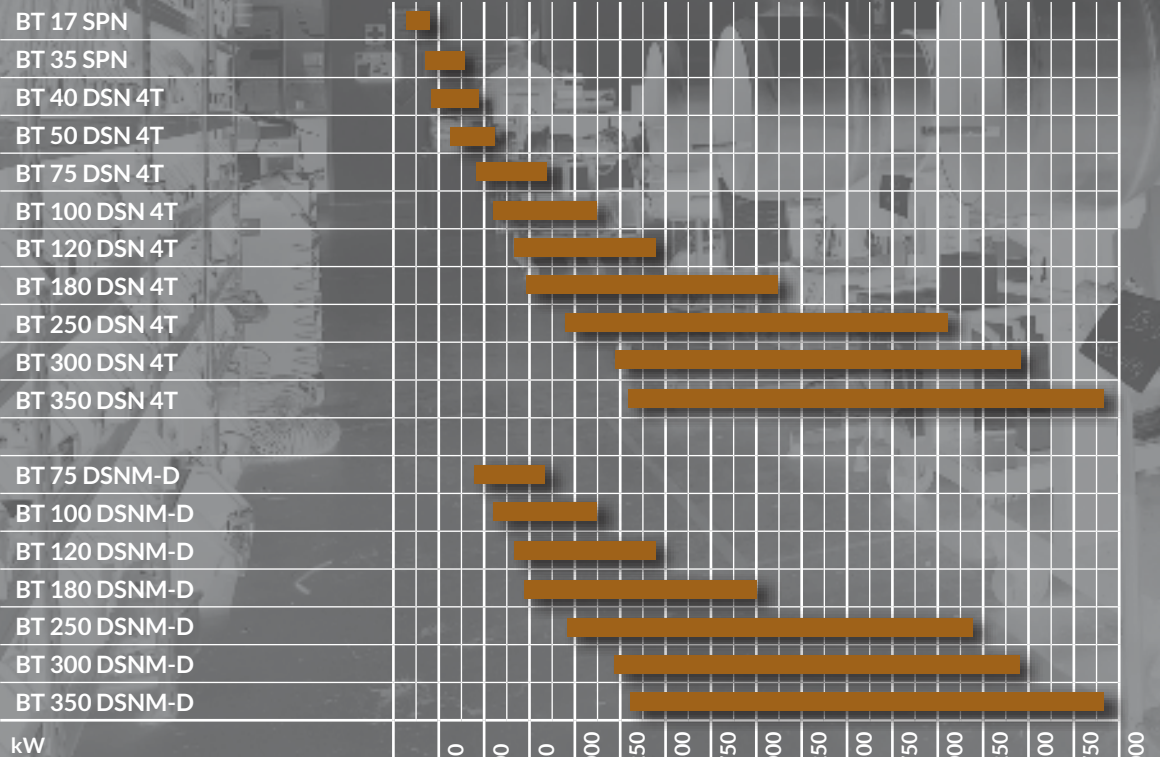

### GI...DSPN-D

Two-stage progressive/modulating extra heavy oil burners with mechanical cam.

## TWO-STAGE PROGRESSIVE HEAVY OIL BURNERS

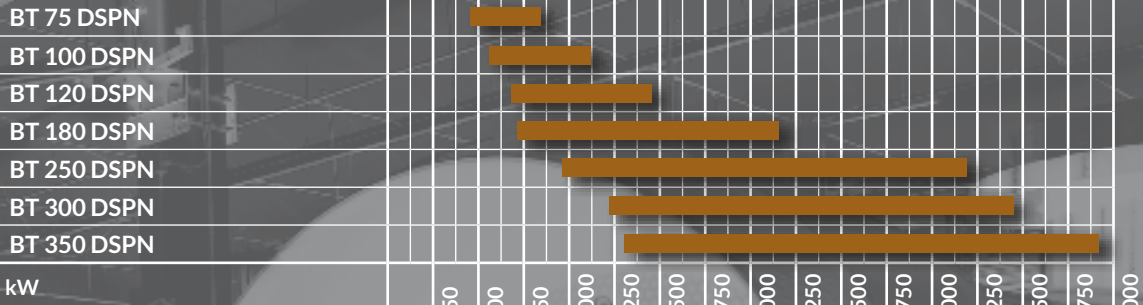

## TWO-STAGE PROGRESSIVE HEAVY OIL INDUSTRIAL BURNERS

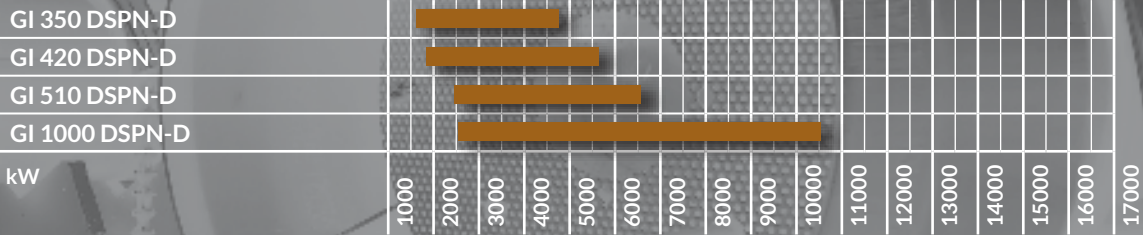



BT 17 N

BT 17 SPN

**Heavy oil burner. Operation:**

Adjusting the combustion head.

Maintenance facilitated by the possibility of removing the combustion head without having to remove the burner from the boiler.

Sliding boiler coupling flange to adapt the blast-pipe to the various types of boilers.

Combustion air intake with butterfly valve. Air flow adjustment:

Fully closing air damper on shutdown to avoid loss of heat through the chimney.

Fuel supply circuit made of gear pump with pressure adjustment, shut-off valves and maximum pressure switch.

Fuel supply circuit made of gear pump with pressure adjustment, shut-off valve, control flow valve and maximum pressure switch.

Electric fuel preheater with antigas valve, filter, thermometer, adjustment and minimum thermostats.

Atomisation unit with nozzle-closing pin.

Flame detection by photoresistance.

Electric protection rating:

	BT 17 N	BT 17 SPN
	single-stage	pressure drop two-stage
Adjusting the combustion head.	•	•
Maintenance facilitated by the possibility of removing the combustion head without having to remove the burner from the boiler.	•	•
Sliding boiler coupling flange to adapt the blast-pipe to the various types of boilers.	•	•
Combustion air intake with butterfly valve. Air flow adjustment:	manual	electric servomotor
Fully closing air damper on shutdown to avoid loss of heat through the chimney.		•
Fuel supply circuit made of gear pump with pressure adjustment, shut-off valves and maximum pressure switch.	•	
Fuel supply circuit made of gear pump with pressure adjustment, shut-off valve, control flow valve and maximum pressure switch.		•
Electric fuel preheater with antigas valve, filter, thermometer, adjustment and minimum thermostats.	•	•
Atomisation unit with nozzle-closing pin.	•	•
Flame detection by photoresistance.	•	•
Electric protection rating:	IP40	IP40

HEAVY OIL

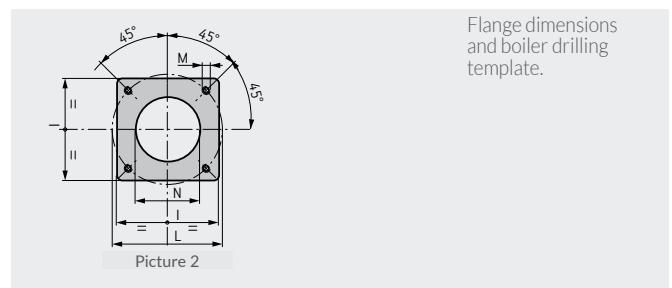
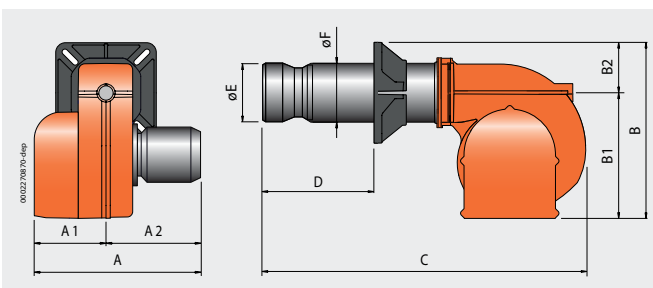

Model	A mm	A1 mm	A2 mm	B mm	B1 mm	B2 mm	C mm	D mm	E mm	F mm	I mm	L mm	M mm	N mm	Pic.
BT 17 N	520	260	260	440	305	135	965	118 ÷ 320	135	115	185	170 ÷ 210	M10	145	2
BT 17 SPN	520	260	260	440	305	135	965	118 ÷ 320	135	115	185	170 ÷ 210	M10	145	2

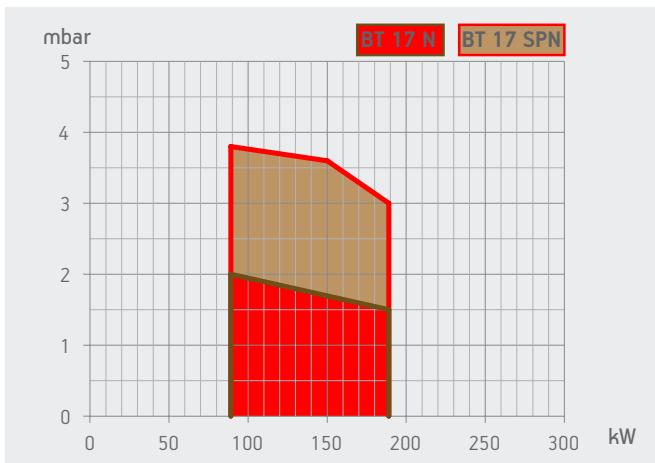

Model	Size of packaging			Weight kg
	L	P mm	H	
BT 17 N	1070	650	600	83
BT 17 SPN	1070	650	600	85

	Thermal output kW	Model	Part no.	Max visc. °E at 50°C	Electrical supply	Motor kW	Tank heating element kW	Notes
Frequency 50 Hz								
	89 ÷ 189	<b>BT 17 N</b>	<b>20080010</b>	7	3N AC 50Hz 400V	0,37	1,8	
	89 ÷ 189	<b>BT 17 SPN</b>	<b>2040111</b>	7	3N AC 50Hz 400V	0,37	1,8	4)
Frequency 60 Hz								
	89 ÷ 189	<b>BT 17 N</b>	<b>20085410</b>	7	3N AC 60Hz 380V	0,55	1,8	
	89 ÷ 189	<b>BT 17 SPN</b>	<b>20405420</b>	7	3N AC 60Hz 380V	0,55	1,8	4)

## KIT FOR HEAVY OIL

DESCRIPTION	PART NO.
Kit for heavy oil up 20°E at 50°C BT 17 SPN	98000305
Kit for heavy oil with low sulphur content and max viscosity 15°E a 50°C BT 17 SPN	98000314

## HEAVY OIL BURNER ACCESSORIES

Line filter, flex hoses, nozzle, boiler coupling kit.

## NOTES

4 Equipped with air closure device.  
Net calorific value of heavy oil: Hi = 40,19 MJ/kg = 9600 kcal/kg.



### Heavy oil burner. Operation:

Adjusting the combustion head.

Maintenance facilitated by the possibility of removing the combustion head without having to remove the burner from the boiler.

Sliding boiler coupling flange to adapt the blast-pipe to the various types of boilers.

Combustion air intake with butterfly valve. Air flow adjustment:

Fully closing air damper on shutdown to avoid loss of heat through the chimney.

Fuel supply circuit made of gear pump with pressure adjustment, shut-off valves and maximum pressure switch.

Fuel supply circuit made of gear pump with pressure adjustment, shut-off valve, control flow valve and maximum pressure switch.

Electric fuel preheater with antigas valve, filter, thermometer, adjustment and minimum thermostats.

Atomisation unit with nozzle-closing pin.

Flame detection by photoresistance.

Electric protection rating:

	BT 35 SPN	BT 40 DSN 4T
pressure drop two-stage		two-stage
Adjusting the combustion head.	•	•
Maintenance facilitated by the possibility of removing the combustion head without having to remove the burner from the boiler.	•	•
Sliding boiler coupling flange to adapt the blast-pipe to the various types of boilers.	•	•
Combustion air intake with butterfly valve. Air flow adjustment:	electric servomotor	electric servomotor
Fully closing air damper on shutdown to avoid loss of heat through the chimney.	•	•
Fuel supply circuit made of gear pump with pressure adjustment, shut-off valves and maximum pressure switch.		•
Fuel supply circuit made of gear pump with pressure adjustment, shut-off valve, control flow valve and maximum pressure switch.	•	
Electric fuel preheater with antigas valve, filter, thermometer, adjustment and minimum thermostats.	•	•
Atomisation unit with nozzle-closing pin.	•	•
Flame detection by photoresistance.	•	•
Electric protection rating:	IP40	IP40

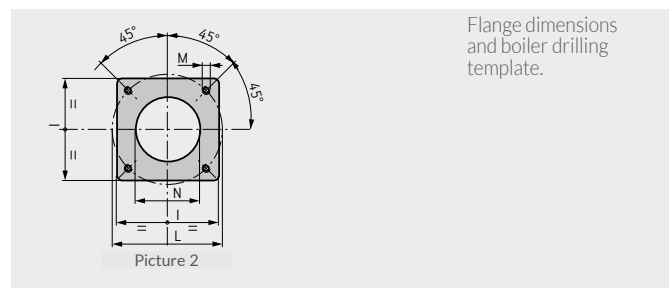
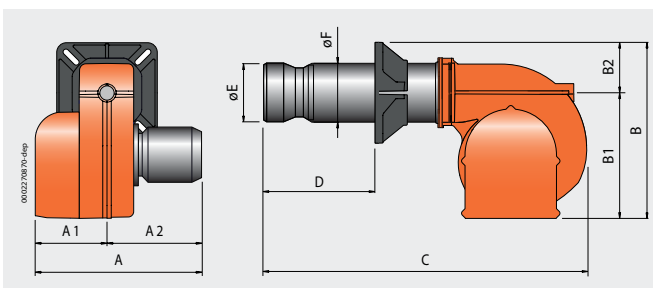

Model	A mm	A1 mm	A2 mm	B mm	B1 mm	B2 mm	C mm	D mm	E mm	F mm	I mm	L mm	M mm	N mm	Pic.
BT 35 SPN	520	260	260	440	305	135	985	120 ÷ 305	155	135	215	200 ÷ 245	M12	165	2
BT 40 DSN 4T	590	260	330	415	305	110	985	120 ÷ 305	155	135	215	200 ÷ 245	M12	165	2

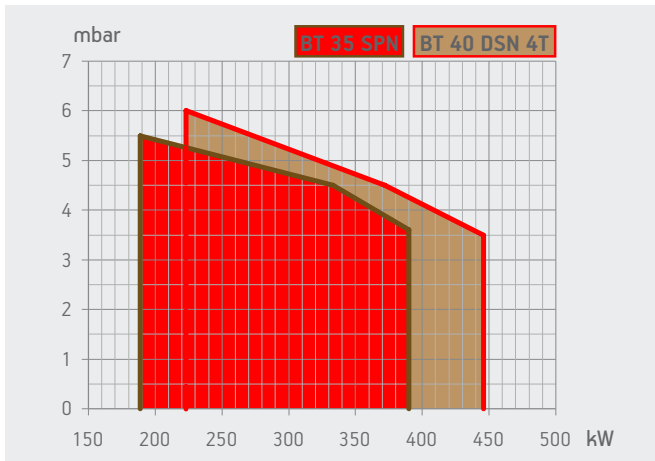

Model	Size of packaging			Weight kg
	L	P mm	H	
BT 35 SPN	1070	650	600	85
BT 40 DSN 4T	1070	650	600	85

	Thermal output kW	Model	Part no.	Max visc.	Electrical supply	Motor	Tank heating element	Notes
				°E at 50°C		kW	kW	
Frequency 50 Hz								
	189 ÷ 390	<b>BT 35 SPN</b>	<b>2052110</b>	7	3N AC 50Hz 400V	0,55	3,5	4)
	223 ÷ 446	<b>BT 40 DSN 4T</b>	<b>2058010</b>	7	3N AC 50Hz 400V	0,55	3,5	4)
Frequency 60 Hz								
	189 ÷ 390	<b>BT 35 SPN</b>	<b>20525420</b>	7	3N AC 60Hz 380V	0,76	3,5	4)
	223 ÷ 446	<b>BT 40 DSN 4T</b>	<b>20585410</b>	7	3N AC 60Hz 380V	0,76	3,5	4)

### KIT FOR HEAVY OIL

DESCRIPTION	PART NO.
Kit for heavy oil up 20°E at 50°C	
BT 35 SPN	98000305
BT 40 DSN	98000301
Kit for heavy oil with low sulphur content and max viscosity 15°E at 50°C	
BT 35 SPN	98000314
BT 40 SPN	98000306

### HEAVY OIL BURNER ACCESSORIES

Line filter, flex hoses, nozzle, boiler coupling kit.

### NOTES

4 Equipped with air closure device.  
 Net calorific value of heavy oil: Hi = 40,19 MJ/kg = 9600 kcal/kg.





## BT 50 DSN 4T

### Heavy oil burner. Operation:

two-stage

Adjusting the combustion head.	•
Maintenance facilitated by the possibility of removing the combustion head without having to remove the burner from the boiler.	•
Sliding boiler coupling flange to adapt the blast-pipe to the various types of boilers.	•
Combustion air intake with butterfly valve. Air flow adjustment:	electric servomotor
Fully closing air damper on shutdown to avoid loss of heat through the chimney.	•
Fuel supply circuit made of gear pump with pressure adjustment, shut-off valves and maximum pressure switch.	•
Electric fuel preheater with antigas valve, filter, thermometer, adjustment and minimum thermostats.	•
Atomisation unit with nozzle-closing pin.	•
Flame detection by photoresistance.	•
Electric protection rating:	IP40

HEAVY OIL

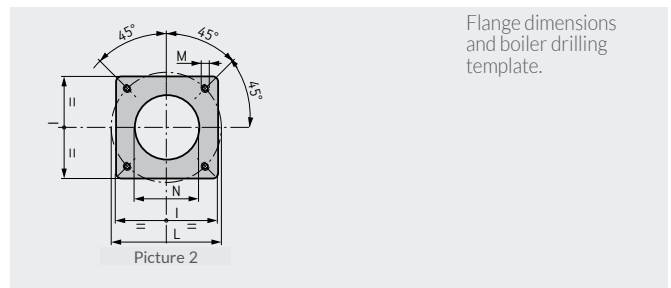
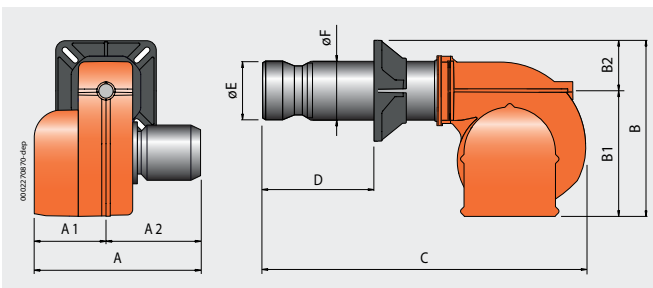

Model	A mm	A1 mm	A2 mm	B mm	B1 mm	B2 mm	C mm	D mm	E mm	F mm	I mm	L mm	M mm	N mm	Pic.
BT 50 DSN 4T	690	340	350	510	400	110	1155	110 ÷ 375	155	135	215	200 ÷ 245	M12	165	2

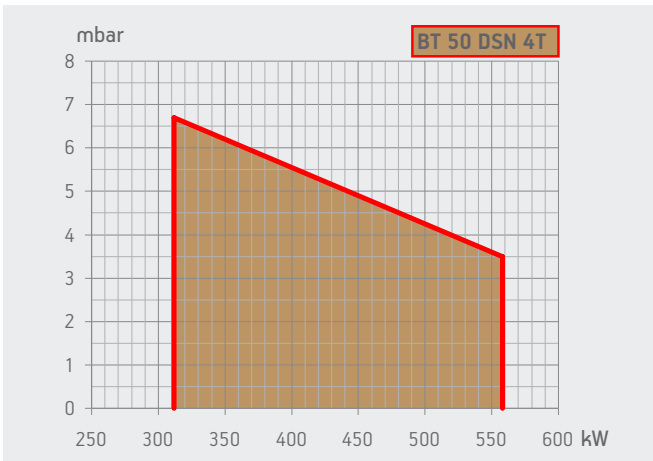

Model	Size of packaging			Weight kg
	L	P mm	H	
BT 50 DSN 4T	1530	760	700	110

	Thermal output kW	Model	Part no.	Max visc.	Electrical supply	Motor kW	Tank heating element kW	Notes
				°E at 50°C				
	312 ÷ 558	BT 50 DSN 4T Frequency 50 Hz	2061010	7	3N AC 50Hz 400V	1,1	6	4)
	312 ÷ 558	BT 50 DSN 4T Frequency 60 Hz	20615410	7	3N AC 60Hz 380V	1,5	6	4)

## KIT FOR HEAVY OIL

DESCRIPTION	PART NO.
Kit for heavy oil up 20°E at 50°C	98000301
Kit for heavy oil with low sulphur content and max viscosity 15°E at 50°C	98000306

## HEAVY OIL BURNER ACCESSORIES

Line filter, flex hoses, nozzle, boiler coupling kit.

## NOTES

4 Equipped with air closure device.  
Net calorific value of heavy oil: Hi = 40,19 MJ/kg = 9600 kcal/kg.



BT 75 DSN 4T



BT 75 DSNM-D



BT 75 DSPN

**Heavy oil burner. Operation:**

**Extra heavy oil burner. Operation:**

Continuous modulation operation by installing P.I.D. controller in the control panel (to be ordered separately with modulation probe).

Modulation ratio:

Adjusting the combustion head.

Maintenance facilitated by the possibility of removing the combustion head without having to remove the burner from the boiler.

Sliding boiler coupling flange to adapt the blast-pipe to the various types of boilers.

Combustion air intake with butterfly valve. Air flow adjustment:

Fully closing air damper on shutdown to avoid loss of heat through the chimney.

Electric motor for pump drive.

Fuel supply circuit made of gear pump with pressure adjustment, shut-off valves and maximum pressure switch.

Fuel supply circuit made of gear pump with pressure adjustment, shut-off valves control flow valve and maximum pressure switch.

Fuel supply circuit made of gear pump with pressure adjustment, control flow valve and maximum pressure switch.

Electric fuel preheater with antigas valve, filter, thermometer, adjustment and minimum thermostats.

Electric fuel preheater with antigas valve, self-cleaning filter, thermometer, adjustment and minimum thermostats.

Atomisation unit with nozzle-closing pin.

Atomisation unit with magnet to control the outlet/nozzle return pins.

Heating element for pump, valve and atomisation unit.

Flame detection by photoresistance.

Electric protection rating:

BT 75 DSN 4T

BT 75 DSNM-D

BT 75 DSPN

two-stage

two-stage

mechanical  
two-stage  
progressive

•

1:2

•

•

•

•

•

•

•

•

•

electric  
servomotor

electric  
servomotor

mechanical  
cam

•

•

•

•

•

•

•

•

•

•

IP40

IP40

IP40

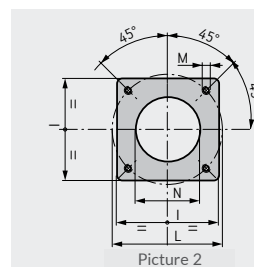
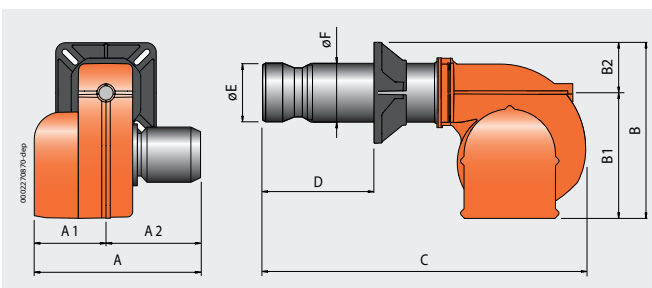

Flange dimensions and boiler drilling template.

Model	A mm	A1 mm	A2 mm	B mm	B1 mm	B2 mm	C mm	D mm	E mm	F mm	I mm	L mm	M mm	N mm	Pic.
BT 75 DSN 4T	690	340	350	530	400	130	1385	170 ÷ 430	205	160	260	225 ÷ 300	M12	170	2
BT 75 DSNM-D	860	510	350	545	415	130	1385	170 ÷ 430	205	160	260	225 ÷ 300	M12	170	2
BT 75 DSPN	860	510	350	545	415	130	1385	195 ÷ 515	205	160	260	225 ÷ 300	M12	170	2

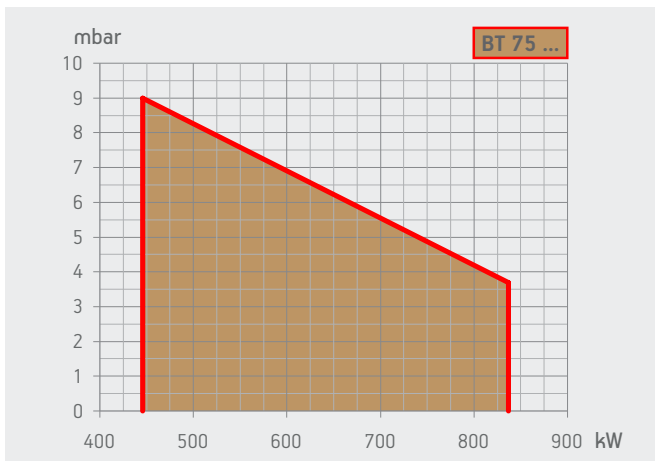

Model	Size of packaging			Weight kg
	L	P mm	H	
BT 75 DSN 4T	1530	760	700	117
BT 75 DSNM-D	1730	1030	880	140
BT 75 DSPN	1730	1030	880	147

	Thermal output kW	Model	Part no.	Max visc. °E at 50°C	Electrical supply	Motor kW	Tank heating element kW	Notes
		Frequency 50 Hz						
	446 ÷ 837	<b>BT 75 DSN 4T</b>	<b>2071010</b>	7	3N AC 50Hz 400V	1,10	6,0	4)
	446 ÷ 837	<b>BT 75 DSNM-D</b>	<b>2500010</b>	50	3N AC 50Hz 400V	1,10+0,55	10,5	4)
	446 ÷ 837	<b>BT 75 DSPN</b>	<b>2610010</b>	7	3N AC 50Hz 400V	1,10+0,55	10,5	4)
		Frequency 60 Hz						
	446 ÷ 837	<b>BT 75 DSN 4T</b>	<b>20715410</b>	7	3N AC 60Hz 380V	1,50	6,0	4)
	446 ÷ 837	<b>BT 75 DSNM-D</b>	<b>25005410</b>	50	3N AC 60Hz 380V	1,50+0,65	10,5	4)
	446 ÷ 837	<b>BT 75 DSPN</b>	<b>26105410</b>	7	3N AC 60Hz 380V	1,50+0,65	10,5	4)

## TO COMPLETE THE BURNER

### DESCRIPTION

BT 75 DSNM-D/75 DSPN: nozzle with 1 ÷ 3 ratio (see page 295)

## MODULATING MODE

### DESCRIPTION

BT 75 DSPN: modulation kit

### PART NO.

98000055

BT 75 DSPN: modulating probe (see page 294)

## KIT FOR HEAVY OIL

### DESCRIPTION

Kit for heavy oil up 20°E at 50°C

BT 75 DSN 4T

### PART NO.

98000301

Kit for heavy oil up to 50°E at 50°C

BT 75 DSPN

98000315

Kit for heavy oil with low sulphur content and max viscosity 15°E at 50°C

BT 75 DSN 4T

98000306

BT 75 DSPN

98000318

## OPTIONALS

### DESCRIPTION

BT 75 DSNM-D/75 DSPN: extra heavy oil burner operation max viscosity 100°E at 50°C

## HEAVY OIL BURNER ACCESSORIES

BT 75 DSN 4T: line filter, flex hoses, nozzles, boiler coupling kit.

BT 75 DSNM-D: self-cleaning, line filter with heating element and thermostat, flex hoses, boiler coupling kit.

BT 75 DSPN: line filter, flex hoses, boiler coupling kit.

## NOTES

4 Equipped with air closure device.

Net calorific value of heavy oil: Hi = 40,19 MJ/kg = 9600 kcal/kg.



BT 100 DSN 4T



BT 100 DSNM-D



BT 100 DSPN

### Heavy oil burner. Operation:

### Extra heavy oil burner. Operation:

Continuous modulation operation by installing P.I.D. controller in the control panel (to be ordered separately with modulation probe).

Modulation ratio:

Adjusting the combustion head.

Maintenance facilitated by the possibility of removing the combustion head without having to remove the burner from the boiler.

Sliding boiler coupling flange to adapt the blast-pipe to the various types of boilers.

Combustion air intake with butterfly valve. Air flow adjustment:

Fully closing air damper on shutdown to avoid loss of heat through the chimney.

Electric motor for pump drive.

Fuel supply circuit made of gear pump with pressure adjustment, shut-off valves and maximum pressure switch.

Fuel supply circuit made of gear pump with pressure adjustment, shut-off valves, control flow valve and maximum pressure switch.

Fuel supply circuit made of gear pump with pressure adjustment, control flow valve and maximum pressure switch.

Electric fuel preheater with antigas valve, filter, thermometer, adjustment and minimum thermostats.

Electric fuel preheater with antigas valve, self-cleaning filter, thermometer, adjustment and minimum thermostats.

Atomisation unit with nozzle-closing pin.

Atomisation unit with magnet to control the outlet/nozzle return pins.

Heating element for pump, valve and atomisation unit.

Flame detection by photoresistance.

Electric protection rating:

	BT 100 DSN 4T	BT 100 DSNM-D	BT 100 DSPN
	two-stage		mechanical two-stage progressive
		two-stage	
Continuous modulation operation by installing P.I.D. controller in the control panel (to be ordered separately with modulation probe).			•
Modulation ratio:			1:2
Adjusting the combustion head.	•	•	•
Maintenance facilitated by the possibility of removing the combustion head without having to remove the burner from the boiler.	•	•	•
Sliding boiler coupling flange to adapt the blast-pipe to the various types of boilers.	•	•	•
Combustion air intake with butterfly valve. Air flow adjustment:	electric servomotor	electric servomotor	mechanical cam
Fully closing air damper on shutdown to avoid loss of heat through the chimney.	•	•	•
Electric motor for pump drive.		•	•
Fuel supply circuit made of gear pump with pressure adjustment, shut-off valves and maximum pressure switch.	•		
Fuel supply circuit made of gear pump with pressure adjustment, shut-off valves, control flow valve and maximum pressure switch.		•	
Fuel supply circuit made of gear pump with pressure adjustment, control flow valve and maximum pressure switch.			•
Electric fuel preheater with antigas valve, filter, thermometer, adjustment and minimum thermostats.	•		
Electric fuel preheater with antigas valve, self-cleaning filter, thermometer, adjustment and minimum thermostats.		•	•
Atomisation unit with nozzle-closing pin.	•		
Atomisation unit with magnet to control the outlet/nozzle return pins.		•	•
Heating element for pump, valve and atomisation unit.		•	
Flame detection by photoresistance.	•	•	•
Electric protection rating:	IP40	IP40	IP40

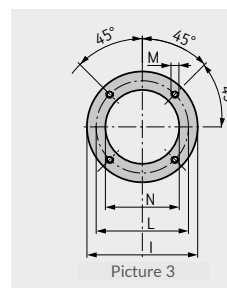
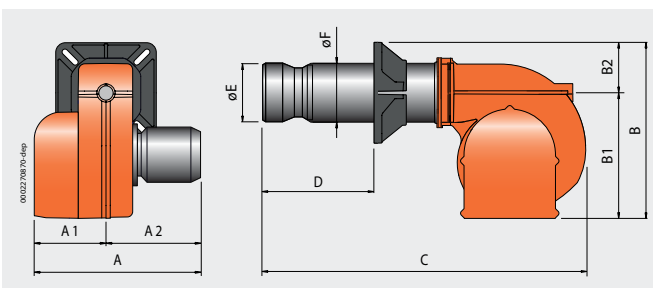

Flange dimensions and boiler drilling template.

Model	A mm	A1 mm	A2 mm	B mm	B1 mm	B2 mm	C mm	D mm	E mm	F mm	I mm	L mm	M mm	N mm	Pic.
BT 100 DSN 4T	690	340	350	560	400	160	1320	210 ÷ 400	230	195	320	276	M16	240	3
BT 100 DSNM-D	860	510	350	560	400	160	1320	210 ÷ 400	230	195	320	276	M16	240	3
BT 100 DSPN	860	510	350	635	475	160	1320	210 ÷ 400	230	195	320	276	M16	240	3

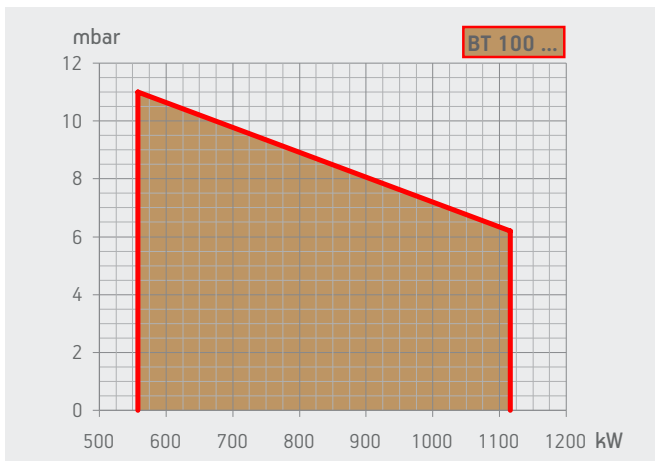

Model	Size of packaging			Weight kg
	L	P mm	H	
BT 100 DSN 4T	1530	760	700	120
BT 100 DSNM-D	1730	1030	880	145
BT 100 DSPN	1730	1030	880	150

	Thermal output kW	Model	Part no.	Max visc. °E at 50°C	Electrical supply	Motor kW	Tank heating element kW	Notes
		Frequency 50 Hz						
	558 ÷ 1116	<b>BT 100 DSN 4T</b>	<b>2076010</b>	7	3N AC 50Hz 400V	1,50	7,5	4)
	558 ÷ 1116	<b>BT 100 DSNM-D</b>	<b>2503010</b>	50	3N AC 50Hz 400V	1,50+0,55	10,5	4)
	558 ÷ 1116	<b>BT 100 DSPN</b>	<b>2615010</b>	7	3N AC 50Hz 400V	1,50+0,55	10,5	4)
		Frequency 60 Hz						
	558 ÷ 1116	<b>BT 100 DSN 4T</b>	<b>20765410</b>	7	3N AC 60Hz 380V	2,60	7,5	4)
	558 ÷ 1116	<b>BT 100 DSNM-D</b>	<b>25035410</b>	50	3N AC 60Hz 380V	2,60+0,65	10,5	4)
	558 ÷ 1116	<b>BT 100 DSPN</b>	<b>26155410</b>	7	3N AC 60Hz 380V	2,60+0,65	10,5	4)

## TO COMPLETE THE BURNER

### DESCRIPTION

BT 100 DSNM-D/100 DSPN: nozzle with 1 ÷ 3 ratio (see page 295)

## MODULATING MODE

### DESCRIPTION

BT 100 DSPN: modulation kit 98000055

BT 100 DSPN: modulating probe (see page 294)

## KIT FOR HEAVY OIL

### DESCRIPTION

DESCRIPTION	PART NO.
Kit for heavy oil up 20°E at 50°C	
BT 100 DSN 4T	98000301
Kit for heavy oil up to 50°E at 50°C	
BT 100 DSPN	98000315
Kit for heavy oil with low sulphur content and max viscosity 15°E at 50°C	
BT 100 DSN 4T	98000306
BT 100 DSPN	98000318

## NOTES

4 Equipped with air closure device.  
Net calorific value of heavy oil: Hi = 40,19 MJ/kg = 9600 kcal/kg.

## OPTIONALS

### DESCRIPTION

BT 100 DSNM-D/100 DSPN: extra heavy oil burner operation max viscosity 100°E at 50°C

## HEAVY OIL BURNER ACCESSORIES

BT 100 DSN 4T: line filter, flex hoses, nozzles, boiler coupling kit.

BT 100 DSNM-D: self-cleaning, line filter with heating element and thermostat, flex hoses, boiler coupling kit.

BT 100 DSPN: line filter, flex hoses, boiler coupling kit.



BT 120 DSN 4T



BT 120 DSN 4T HINGED



BT 120 DSNM-D



BT 120 DSPN

**Heavy oil burner. Operation:**

**Extra heavy oil burner. Operation:**

Continuous modulation operation by installing P.I.D. controller in the control panel (to be ordered separately with modulation probe).

Modulation ratio:

Adjusting the combustion head.

Maintenance facilitated by the possibility of removing the combustion head without having to remove the burner from the boiler.

Fixed boiler coupling flange.

Sliding boiler coupling flange to adapt the blast-pipe to the various types of boilers.

Easy maintenance thanks to the two-sides hinge which allows the removal of the combustion head without having to remove the burner from the boiler.

Combustion air intake with butterfly valve. Air flow adjustment:

Fully closing air damper on shutdown to avoid loss of heat through the chimney.

Electric motor for pump drive.

Fuel supply circuit made of gear pump with pressure adjustment, shut-off valves and maximum pressure switch.

Fuel supply circuit made of gear pump with pressure adjustment, shut-off valves, control flow valve and maximum pressure switch.

Fuel supply circuit made of gear pump with pressure adjustment, control flow valve and maximum pressure switch.

Electric fuel preheater with antigas valve, filter, thermometer, adjustment and minimum thermostats.

Electric fuel preheater with antigas valve, self-cleaning filter, thermometer, adjustment and minimum thermostats.

Atomisation unit with nozzle-closing pin.

Atomisation unit with magnet to control the outlet/nozzle return pins.

Heating element for pump, valve and atomisation unit.

Flame detection by photoresistance.

Electric protection rating:

	BT 120 DSN 4T	BT 120 DSN 4T Hinged	BT 120 DSNM-D	BT 120 DSPN
	two-stage	two-stage		mechanical two-stage progressive
			two-stage	
Continuous modulation operation by installing P.I.D. controller in the control panel (to be ordered separately with modulation probe).				•
Modulation ratio:				1:2
Adjusting the combustion head.	•	•	•	•
Maintenance facilitated by the possibility of removing the combustion head without having to remove the burner from the boiler.	•	•	•	•
Fixed boiler coupling flange.		•		
Sliding boiler coupling flange to adapt the blast-pipe to the various types of boilers.	•		•	•
Easy maintenance thanks to the two-sides hinge which allows the removal of the combustion head without having to remove the burner from the boiler.		•		
Combustion air intake with butterfly valve. Air flow adjustment:	electric servomotor	electric servomotor	electric servomotor	mechanical cam
Fully closing air damper on shutdown to avoid loss of heat through the chimney.	•	•	•	•
Electric motor for pump drive.			•	•
Fuel supply circuit made of gear pump with pressure adjustment, shut-off valves and maximum pressure switch.	•	•		
Fuel supply circuit made of gear pump with pressure adjustment, shut-off valves, control flow valve and maximum pressure switch.			•	
Fuel supply circuit made of gear pump with pressure adjustment, control flow valve and maximum pressure switch.				•
Electric fuel preheater with antigas valve, filter, thermometer, adjustment and minimum thermostats.	•	•		
Electric fuel preheater with antigas valve, self-cleaning filter, thermometer, adjustment and minimum thermostats.			•	•
Atomisation unit with nozzle-closing pin.	•	•		
Atomisation unit with magnet to control the outlet/nozzle return pins.			•	•
Heating element for pump, valve and atomisation unit.	•	•	•	•
Flame detection by photoresistance.				•
Electric protection rating:	IP40	IP40	IP40	IP40

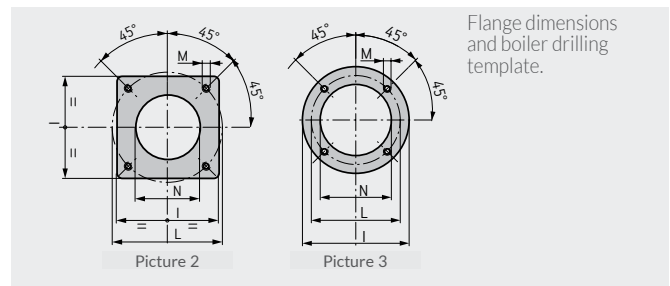
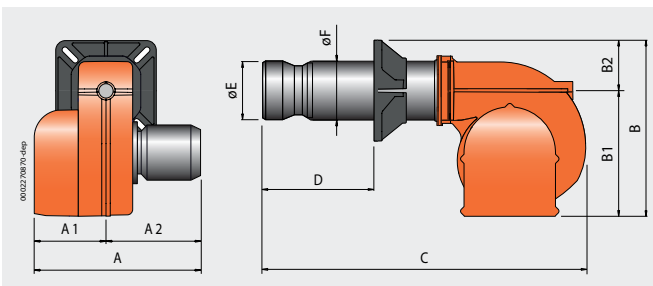

Model	A mm	A1 mm	A2 mm	B mm	B1 mm	B2 mm	C mm	D mm	E mm	F mm	I mm	L mm	M mm	N mm	Pic.
BT 120 DSN 4T	835	385	450	610	450	160	1400	185 ÷ 450	230	195	320	276	M16	240	3
BT 120 DSN 4T Hinged	690	320	370	825	665	160	1125	265	230	195	300	340	M16	240	2
BT 120 DSNM-D	910	460	450	610	450	160	1400	185 ÷ 450	230	195	320	276	M16	240	3
BT 120 DSPN	910	460	450	680	520	160	1400	185 ÷ 450	230	195	320	276	M16	240	3

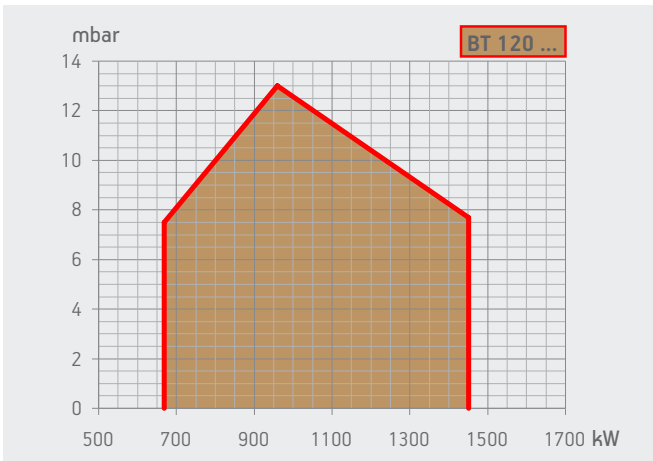

Model	Size of packaging			Weight kg
	L	P mm	H	
BT 120 DSN 4T	1730	1030	880	190
BT 120 DSN 4T Hinged	1360	990	1200	190
BT 120 DSNM-D	1730	1030	880	230
BT 120 DSPN	1730	1030	880	224

	Thermal output kW	Model	Part no.	Max visc. °E at 50°C	Electrical supply	Motor kW	Tank heating element kW	Notes
Frequency 50 Hz								
	669 ÷ 1451	<b>BT 120 DSN 4T</b>	<b>2081010</b>	7	3N AC 50Hz 400V	2,2	10,5	4)
	669 ÷ 1451	<b>BT 120 DSN 4T Hinged</b>	<b>2081011</b>	7	3N AC 50Hz 400V	2,2	10,5	4)
	669 ÷ 1451	<b>BT 120 DSNM-D</b>	<b>2505010</b>	50	3N AC 50Hz 400V	2,2+1,1	10,5	4)
	669 ÷ 1451	<b>BT 120 DSPN</b>	<b>2620010</b>	7	3N AC 50Hz 400V	2,2+1,1	10,5	4)
Frequency 60 Hz								
	669 ÷ 1451	<b>BT 120 DSN 4T</b>	<b>20815410</b>	7	3N AC 60Hz 380V	3,5	10,5	4)
	669 ÷ 1451	<b>BT 120 DSN 4T Hinged</b>	<b>20815411</b>	7	3N AC 60Hz 380V	3,5	10,5	4)
	669 ÷ 1451	<b>BT 120 DSNM-D</b>	<b>25055410</b>	50	3N AC 60Hz 380V	3,5+1,3	10,5	4)
	669 ÷ 1451	<b>BT 120 DSPN</b>	<b>26205410</b>	7	3N AC 60Hz 380V	3,5+1,3	10,5	4)

## TO COMPLETE THE BURNER

### DESCRIPTION

BT 120 DSNM-D/120 DSPN: nozzle with 1 ÷ 3 ratio (see page 295)

## MODULATING MODE

### DESCRIPTION

BT 120 DSPN: modulation kit 98000055

BT 120 DSPN: modulating probe (see page 294)

## KIT FOR HEAVY OIL

### DESCRIPTION

DESCRIPTION	PART NO.
Kit for heavy oil up to 20°E at 50°C	
BT 120 DSN 4T	98000301
Kit for heavy oil up to 50°E at 50°C	
BT 120 DSPN	98000315
Kit for heavy oil with low sulphur content and max viscosity 15°E at 50°C	
BT 120 DSN 4T	98000306
BT 120 DSPN	98000318

## NOTES

4 Equipped with air closure device.

17 Not including steam regulator.

Net calorific value of heavy oil: Hi = 40,19 MJ/kg = 9600 kcal/kg.

## OPTIONALS

### DESCRIPTION

Steam pre-heater (17)

BT 120 DSNM-D/120 DSPN: extra heavy oil burner operation max viscosity 100°E at 50°C

## HEAVY OIL BURNER ACCESSORIES

BT 120 DSN 4T: line filter, flex hoses, nozzles, boiler coupling kit.

BT 120 DSNM-D: self-cleaning, line filter with heating element and thermostat, flex hoses, boiler coupling kit.

BT 120 DSPN: line filter, flex hoses, boiler coupling kit.





BT 180 DSN 4T



BT 180 DSN 4T HINGED



BT 180 DSNM-D



BT 180 DSPN

**Heavy oil burner. Operation:**

**Extra heavy oil burner. Operation:**

Continuous modulation operation by installing P.I.D. controller in the control panel (to be ordered separately with modulation probe).

Modulation ratio:

Adjusting the combustion head.

Maintenance facilitated by the possibility of removing the combustion head without having to remove the burner from the boiler.

Fixed boiler coupling flange.

Sliding boiler coupling flange to adapt the blast-pipe to the various types of boilers.

Easy maintenance thanks to the two-sides hinge which allows the removal of the combustion head without having to remove the burner from the boiler.

Combustion air intake with butterfly valve. Air flow adjustment:

Fully closing air damper on shutdown to avoid loss of heat through the chimney.

Electric motor for pump drive.

Fuel supply circuit made of gear pump with pressure adjustment, shut-off valves and maximum pressure switch.

Fuel supply circuit made of gear pump with pressure adjustment, shut-off valves, control flow valve and maximum pressure switch.

Fuel supply circuit made of gear pump with pressure adjustment, control flow valve and maximum pressure switch.

Electric fuel preheater with antigas valve, filter, thermometer, adjustment, minimum and safety thermostats.

Electric fuel preheater with antigas valve, self-cleaning filter, thermometer, adjustment, minimum and safety thermostats.

Atomisation unit with nozzle-closing pin.

Atomisation unit with magnet to control the outlet/nozzle return pins.

Heating element for pump, valve and atomisation unit.

Flame detection by photoresistance.

Electric protection rating:

	BT 180 DSN 4T	BT 180 DSN 4T Hinged	BT 180 DSNM-D	BT 180 DSPN
	two-stage	two-stage		mechanical two-stage progressive
			two-stage	
Continuous modulation operation by installing P.I.D. controller in the control panel (to be ordered separately with modulation probe).				•
Modulation ratio:				1:3
Adjusting the combustion head.	•	•	•	•
Maintenance facilitated by the possibility of removing the combustion head without having to remove the burner from the boiler.	•	•	•	•
Fixed boiler coupling flange.		•		
Sliding boiler coupling flange to adapt the blast-pipe to the various types of boilers.	•		•	•
Easy maintenance thanks to the two-sides hinge which allows the removal of the combustion head without having to remove the burner from the boiler.		•		
Combustion air intake with butterfly valve. Air flow adjustment:	electric servomotor	electric servomotor	electric servomotor	mechanical cam
Fully closing air damper on shutdown to avoid loss of heat through the chimney.	•	•	•	•
Electric motor for pump drive.			•	•
Fuel supply circuit made of gear pump with pressure adjustment, shut-off valves and maximum pressure switch.	•	•		
Fuel supply circuit made of gear pump with pressure adjustment, shut-off valves, control flow valve and maximum pressure switch.			•	
Fuel supply circuit made of gear pump with pressure adjustment, control flow valve and maximum pressure switch.				•
Electric fuel preheater with antigas valve, filter, thermometer, adjustment, minimum and safety thermostats.	•	•		
Electric fuel preheater with antigas valve, self-cleaning filter, thermometer, adjustment, minimum and safety thermostats.			•	•
Atomisation unit with nozzle-closing pin.	•	•		
Atomisation unit with magnet to control the outlet/nozzle return pins.			•	•
Heating element for pump, valve and atomisation unit.			•	
Flame detection by photoresistance.	•	•	•	•
Electric protection rating:	IP40	IP40	IP40	IP40

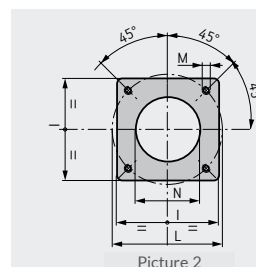
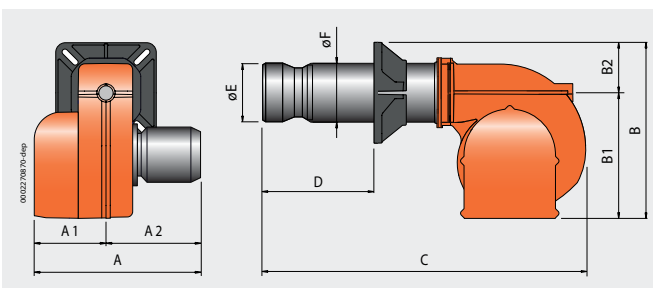

Flange dimensions and boiler drilling template.

Model	A mm	A1 mm	A2 mm	B mm	B1 mm	B2 mm	C mm	D mm	E mm	F mm	I mm	L mm	M mm	N mm	Pic.
BT 180 DSN 4T	940	450	490	610	450	160	1645	200 ÷ 535	260	220	320	280 ÷ 370	M12	230	2
BT 180 DSN 4T Hinged	755	385	370	890	720	170	1210	280	260	225	340	396	M16	275	2
BT 180 DSNM-D	940	450	490	610	450	160	1645	200 ÷ 535	260	220	320	280 ÷ 370	M12	230	2
BT 180 DSPN	940	450	490	610	450	160	1645	200 ÷ 535	260	220	320	280 ÷ 370	M12	230	2

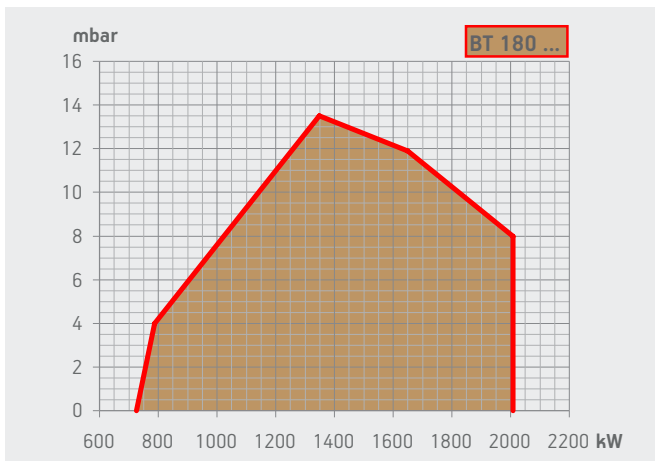

Model	Size of packaging			Weight kg
	L	P mm	H	
BT 180 DSN 4T	1730	1030	880	240
BT 180 DSN 4T Hinged	1360	990	1200	240
BT 180 DSNM-D	1730	1030	880	280
BT 180 DSPN	2030	1150	1010	274

	Thermal output kW	Model	Part no.	Max visc. °E at 50°C	Electrical supply	Motor kW	Tank heating element kW	Notes
Frequency 50 Hz								
	725 ÷ 2009	<b>BT 180 DSN 4T</b>	<b>2086010</b>	7	3N AC 50Hz 400V	3,0	15	4)
	725 ÷ 2009	<b>BT 180 DSN 4T Hinged</b>	<b>2086011</b>	7	3N AC 50Hz 400V	3,0	15	4)
	725 ÷ 2009	<b>BT 180 DSNM-D</b>	<b>2507010</b>	50	3N AC 50Hz 400V	3,0+1,1	15	4)
	725 ÷ 2009	<b>BT 180 DSPN</b>	<b>2625010</b>	7	3N AC 50Hz 400V	3,0+1,1	15	4)
Frequency 60 Hz								
	725 ÷ 2009	<b>BT 180 DSN 4T</b>	<b>20865410</b>	7	3N AC 60Hz 380V	3,5	15	4)
	725 ÷ 2009	<b>BT 180 DSN 4T Hinged</b>	<b>20865411</b>	7	3N AC 60Hz 380V	3,5	15	4)
	725 ÷ 2009	<b>BT 180 DSNM-D</b>	<b>25075410</b>	50	3N AC 60Hz 380V	3,5+1,3	15	4)
	725 ÷ 2009	<b>BT 180 DSPN</b>	<b>26255410</b>	7	3N AC 60Hz 380V	3,5+1,3	15	4)

## TO COMPLETE THE BURNER

### DESCRIPTION

BT 180 DSNM-D/180 DSPN: nozzle with 1 ÷ 3 ratio (see page 295)

## MODULATING MODE

### DESCRIPTION

BT 180 DSPN: modulation kit 98000055

BT 180 DSPN: modulating probe (see page 294)

## KIT FOR HEAVY OIL

### DESCRIPTION

DESCRIPTION	PART NO.
Kit for heavy oil up to 20°E at 50°C	
BT 180 DSN 4T	98000302
Kit for heavy oil up to 50°E at 50°C	
BT 180 DSPN	98000315
Kit for heavy oil with low sulphur content and max viscosity 15°E at 50°C	
BT 180 DSN 4T	98000307
BT 180 DSPN	98000318

## NOTES

- 4 Equipped with air closure device.
  - 17 Not including steam regulator.
- Net calorific value of heavy oil: Hi = 40,19 MJ/kg = 9600 kcal/kg.

## OPTIONALS

### DESCRIPTION

Steam pre-heater (17)

BT 180 DSNM-D/180 DSPN: extra heavy oil burner operation max viscosity 100°E at 50°C

## HEAVY OIL BURNER ACCESSORIES

BT 180 DSN 4T: line filter, flex hoses, nozzles, boiler coupling kit.

BT 180 DSNM-D: self-cleaning, line filter with heating element and thermostat, flex hoses, boiler coupling kit.

BT 180 DSPN: line filter, flex hoses, boiler coupling kit.



BT 250 DSN 4T



BT 250 DSN 4T HINGED



BT 250 DSNM-D



BT 250 DSPN

**Heavy oil burner. Operation:**

**Extra heavy oil burner. Operation:**

Continuous modulation operation by installing P.I.D. controller in the control panel (to be ordered separately with modulation probe).

Modulation ratio:

Adjusting the combustion head.

Maintenance facilitated by the possibility of removing the combustion head without having to remove the burner from the boiler.

Fixed boiler coupling flange.

Sliding boiler coupling flange to adapt the blast-pipe to the various types of boilers.

Easy maintenance thanks to the two-sides hinge which allows the removal of the combustion head without having to remove the burner from the boiler.

Combustion air intake with butterfly valve. Air flow adjustment:

Fully closing air damper on shutdown to avoid loss of heat through the chimney.

Electric motor for pump drive.

Fuel supply circuit made of gear pump with pressure adjustment, shut-off valves and maximum pressure switch.

Fuel supply circuit made of gear pump with pressure adjustment, shut-off valves, control flow valve and maximum pressure switch.

Fuel supply circuit made of gear pump with pressure adjustment, control flow valve and maximum pressure switch.

Electric fuel preheater with antigas valve, filter, thermometer, adjustment minimum and safety thermostats.

Electric fuel preheater with antigas valve, self-cleaning filter, thermometer, adjustment, minimum and safety thermostats.

Atomisation unit with nozzle-closing pin.

Atomisation unit with magnet to control the outlet/nozzle return pins.

Heating element for pump, valve and atomisation unit.

Flame detection by photoresistance.

Electric protection rating:

	BT 250 DSN 4T	BT 250 DSN 4T Hinged	BT 250 DSNM-D	BT 250 DSPN
	two-stage	two-stage		mechanical two-stage progressive
			two-stage	
Continuous modulation operation by installing P.I.D. controller in the control panel (to be ordered separately with modulation probe).				•
Modulation ratio:				1:3
Adjusting the combustion head.	•	•	•	•
Maintenance facilitated by the possibility of removing the combustion head without having to remove the burner from the boiler.	•	•	•	•
Fixed boiler coupling flange.		•		
Sliding boiler coupling flange to adapt the blast-pipe to the various types of boilers.	•		•	•
Easy maintenance thanks to the two-sides hinge which allows the removal of the combustion head without having to remove the burner from the boiler.		•		
Combustion air intake with butterfly valve. Air flow adjustment:	electric servomotor	electric servomotor	electric servomotor	mechanical cam
Fully closing air damper on shutdown to avoid loss of heat through the chimney.	•	•	•	•
Electric motor for pump drive.			•	•
Fuel supply circuit made of gear pump with pressure adjustment, shut-off valves and maximum pressure switch.	•	•		
Fuel supply circuit made of gear pump with pressure adjustment, shut-off valves, control flow valve and maximum pressure switch.			•	
Fuel supply circuit made of gear pump with pressure adjustment, control flow valve and maximum pressure switch.				•
Electric fuel preheater with antigas valve, filter, thermometer, adjustment minimum and safety thermostats.	•	•		
Electric fuel preheater with antigas valve, self-cleaning filter, thermometer, adjustment, minimum and safety thermostats.			•	•
Atomisation unit with nozzle-closing pin.	•	•		
Atomisation unit with magnet to control the outlet/nozzle return pins.			•	•
Heating element for pump, valve and atomisation unit.			•	
Flame detection by photoresistance.	•	•	•	•
Electric protection rating:	IP40	IP40	IP40	IP40

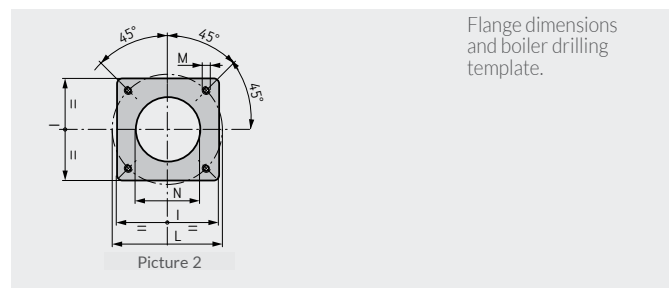
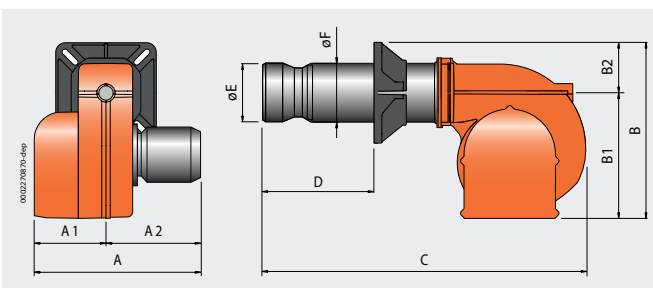

Model	A mm	A1 mm	A2 mm	B mm	B1 mm	B2 mm	C mm	D mm	E mm	F mm	I mm	L mm	M mm	N mm	Pic.
BT 250 DSN 4T	940	450	490	740	580	160	1665	235 ÷ 590	260	220	320	280 ÷ 370	M12	230	2
BT 250 DSN 4T Hinged	890	410	480	1050	870	180	1235	295	260	225	340	396	M16	275	2
BT 250 DSNM-D	1025	535	490	740	580	160	1655	235 ÷ 590	260	220	320	280 ÷ 370	M12	230	2
BT 250 DSPN	1025	535	490	770	580	190	1665	235 ÷ 590	260	220	320	280 ÷ 370	M12	230	2

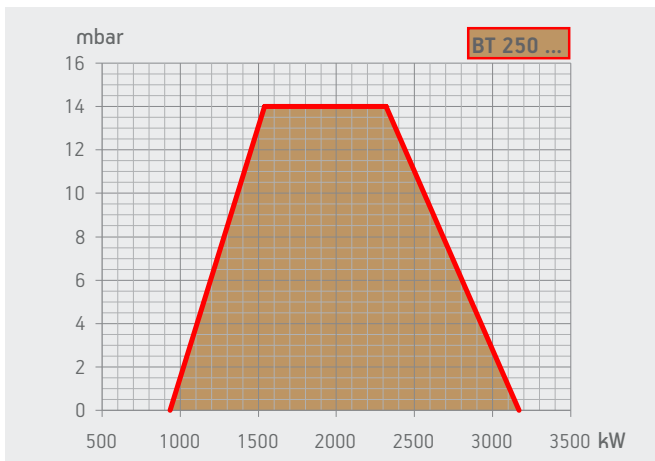

Model	Size of packaging			Weight kg
	L	P mm	H	
BT 250 DSN 4T	1730	1030	880	280
BT 250 DSN 4T Hinged	1410	1170	1470	280
BT 250 DSNM-D	2020	1140	1010	320
BT 250 DSPN	2020	1140	1010	314

	Thermal output kW	Model	Part no.	Max visc. °E at 50°C	Electrical supply	Motor kW	Tank heating element kW	Notes
Frequency 50 Hz								
	937 ÷ 3170	<b>BT 250 DSN 4T</b>	<b>2101010</b>	7	3N AC 50Hz 400V	7,5	18	4)
	937 ÷ 3170	<b>BT 250 DSN 4T Hinged</b>	<b>2101011</b>	7	3N AC 50Hz 400V	7,5	18	4)
	937 ÷ 3170	<b>BT 250 DSNM-D</b>	<b>2515010</b>	50	3N AC 50Hz 400V	7,5+1,1	18	4)
	937 ÷ 3170	<b>BT 250 DSPN</b>	<b>2630010</b>	7	3N AC 50Hz 400V	7,5+1,1	18	4)
Frequency 60 Hz								
	937 ÷ 3170	<b>BT 250 DSN 4T</b>	<b>21015410</b>	7	3N AC 60Hz 380V	9,0+1,3	18	4)
	937 ÷ 3170	<b>BT 250 DSN 4T Hinged</b>	<b>21015411</b>	7	3N AC 60Hz 380V	9,0+1,3	18	4)
	937 ÷ 3170	<b>BT 250 DSNM-D</b>	<b>25155410</b>	50	3N AC 60Hz 380V	9,0+1,3	18	4)
	937 ÷ 3170	<b>BT 250 DSPN</b>	<b>26305410</b>	7	3N AC 60Hz 380V	9,0+1,3	18	4)

## TO COMPLETE THE BURNER

### DESCRIPTION

BT 250 DSNM-D/250 DSPN: nozzle with 1 ÷ 3 ratio (see page 295)

## MODULATING MODE

### DESCRIPTION

BT 250 DSPN: modulation kit 98000055

BT 250 DSPN: modulating probe (see page 294)

## KIT FOR HEAVY OIL

### DESCRIPTION

DESCRIPTION	PART NO.
Kit for heavy oil up to 20°E at 50°C	
BT 250 DSN 4T	98000302
Kit for heavy oil up to 50°E at 50°C	
BT 250 DSPN	98000315
Kit for heavy oil with low sulphur content and max viscosity 15°E at 50°C	
BT 250 DSN 4T	98000307
BT 250 DSPN	98000318

## NOTES

4 Equipped with air closure device.

17 Not including steam regulator.

Net calorific value of heavy oil: Hi = 40,19 MJ/kg = 9600 kcal/kg.

## OPTIONALS

### DESCRIPTION

Steam pre-heater (17)

BT 250 DSNM-D/250 DSPN: extra heavy oil burner operation max viscosity 100°E at 50°C

## HEAVY OIL BURNER ACCESSORIES

BT 250 DSN 4T: line filter, flex hoses, nozzles, boiler coupling kit.

BT 250 DSNM-D: self-cleaning, line filter with heating element and thermostat, flex hoses, boiler coupling kit.

BT 250 DSPN: line filter, flex hoses, boiler coupling kit.



BT 300 DSN 4T



BT 300 DSN 4T HINGED



BT 300 DSNM-D



BT 300 DSPN

**Heavy oil burner. Operation:**

**Extra heavy oil burner. Operation:**

Continuous modulation operation by installing P.I.D. controller in the control panel (to be ordered separately with modulation probe).

Modulation ratio:

Adjusting the combustion head.

Maintenance facilitated by the possibility of removing the combustion head without having to remove the burner from the boiler.

Fixed boiler coupling flange.

Sliding boiler coupling flange to adapt the blast-pipe to the various types of boilers.

Easy maintenance thanks to the two-sides hinge which allows the removal of the combustion head without having to remove the burner from the boiler.

Combustion air intake with butterfly valve. Air flow adjustment:

Fully closing air damper on shutdown to avoid loss of heat through the chimney.

Electric motor for pump drive.

Fuel supply circuit made of gear pump with pressure adjustment, shut-off valves and maximum pressure switch.

Fuel supply circuit made of gear pump with pressure adjustment, shut-off valves, control flow valve and maximum pressure switch.

Fuel supply circuit made of gear pump with pressure adjustment, control flow valve and maximum pressure switch.

Electric fuel preheater with antigas valve, filter, thermometer, adjustment, minimum and safety thermostats.

Electric fuel preheater with antigas valve, self-cleaning filter, thermometer, adjustment, minimum and safety thermostats.

Atomisation unit with nozzle-closing pin.

Atomisation unit with magnet to control the outlet/nozzle return pins.

Heating element for pump, valve and atomisation unit.

Flame detection by photoresistance.

Electric protection rating:

	BT 300 DSN 4T	BT 300 DSN 4T Hinged	BT 300 DSNM-D	BT 300 DSPN
	two-stage	two-stage		mechanical two-stage progressive
			two-stage	
Continuous modulation operation by installing P.I.D. controller in the control panel (to be ordered separately with modulation probe).				•
Modulation ratio:				1:3
Adjusting the combustion head.	•	•	•	•
Maintenance facilitated by the possibility of removing the combustion head without having to remove the burner from the boiler.	•	•	•	•
Fixed boiler coupling flange.		•		
Sliding boiler coupling flange to adapt the blast-pipe to the various types of boilers.	•		•	•
Easy maintenance thanks to the two-sides hinge which allows the removal of the combustion head without having to remove the burner from the boiler.		•		
Combustion air intake with butterfly valve. Air flow adjustment:	electric servomotor	electric servomotor	electric servomotor	mechanical cam
Fully closing air damper on shutdown to avoid loss of heat through the chimney.	•	•	•	•
Electric motor for pump drive.				•
Fuel supply circuit made of gear pump with pressure adjustment, shut-off valves and maximum pressure switch.	•	•		
Fuel supply circuit made of gear pump with pressure adjustment, shut-off valves, control flow valve and maximum pressure switch.			•	
Fuel supply circuit made of gear pump with pressure adjustment, control flow valve and maximum pressure switch.				•
Electric fuel preheater with antigas valve, filter, thermometer, adjustment, minimum and safety thermostats.	•	•		
Electric fuel preheater with antigas valve, self-cleaning filter, thermometer, adjustment, minimum and safety thermostats.			•	•
Atomisation unit with nozzle-closing pin.	•	•		
Atomisation unit with magnet to control the outlet/nozzle return pins.			•	•
Heating element for pump, valve and atomisation unit.			•	
Flame detection by photoresistance.	•	•	•	•
Electric protection rating:	IP40	IP40	IP40	IP40

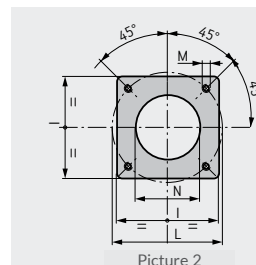
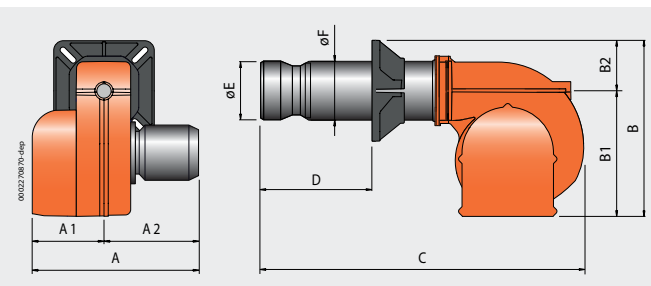

Flange dimensions and boiler drilling template.

Model	A mm	A1 mm	A2 mm	B mm	B1 mm	B2 mm	C mm	D mm	E mm	F mm	I mm	L mm	M mm	N mm	Pic.
BT 300 DSN 4T	1155	645	510	840	620	220	1900	245 ÷ 605	360	275	440	400 ÷ 540	M20	365	2
BT 300 DSN 4T Hinged	945	455	490	1170	950	220	1530	420	360	280	430	509	M18	370	2
BT 300 DSNM-D	1135	625	510	800	580	220	1900	245 ÷ 605	360	275	440	400 ÷ 540	M20	365	2
BT 300 DSPN	1135	625	510	800	580	220	1900	245 ÷ 605	360	275	440	400 ÷ 540	M20	365	2

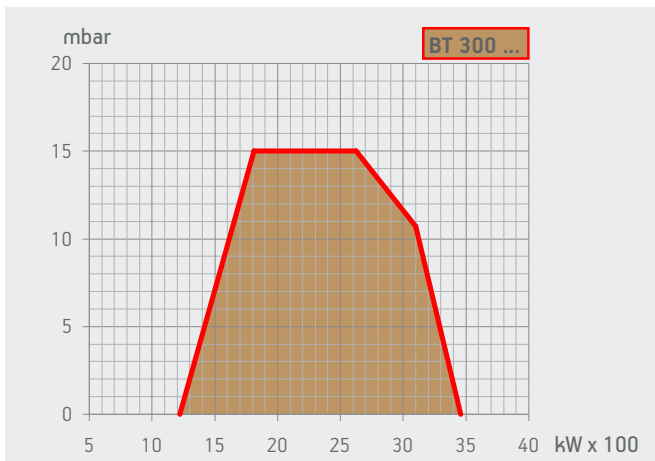

Model	Size of packaging			Weight kg
	L	P mm	H	
BT 300 DSN 4T	2260	1520	1150	350
BT 300 DSN 4T Hinged	1710	1540	1560	350
BT 300 DSNM-D	2260	1520	1150	405
BT 300 DSPN	2260	1520	1150	396

	Thermal output kW	Model	Part no.	Max visc. °E at 50°C	Electrical supply	Motor kW	Tank heating element kW	Notes
Frequency 50 Hz								
	1220 ÷ 3460	<b>BT 300 DSN 4T</b>	<b>2131010</b>	7	3N AC 50Hz 400V	7,5	25,5	4)
	1220 ÷ 3460	<b>BT 300 DSN 4T Hinged</b>	<b>2131011</b>	7	3N AC 50Hz 400V	7,5	25,5	4)
	1220 ÷ 3460	<b>BT 300 DSNM-D</b>	<b>2520010</b>	50	3N AC 50Hz 400V	7,5+2,2	25,5	4)
	1220 ÷ 3460	<b>BT 300 DSPN</b>	<b>2635010</b>	7	3N AC 50Hz 400V	7,5+2,2	25,5	4)
Frequency 60 Hz								
	1220 ÷ 3460	<b>BT 300 DSN 4T</b>	<b>21315410</b>	7	3N AC 60Hz 380V	9,0+1,3	25,5	4)
	1220 ÷ 3460	<b>BT 300 DSN 4T Hinged</b>	<b>21315411</b>	7	3N AC 60Hz 380V	9,0+1,3	25,5	4)
	1220 ÷ 3460	<b>BT 300 DSNM-D</b>	<b>25205410</b>	50	3N AC 60Hz 380V	9,0+2,6	25,5	4)
	1220 ÷ 3460	<b>BT 300 DSPN</b>	<b>26355410</b>	7	3N AC 60Hz 380V	9,0+2,6	25,5	4)

### TO COMPLETE THE BURNER

#### DESCRIPTION

BT 300 DSNM-D/300 DSPN: nozzle with 1 ÷ 3 ratio (see page 295)

### MODULATING MODE

#### DESCRIPTION

BT 300 DSPN: modulation kit 98000055

BT 300 DSPN: modulating probe (see page 294)

### KIT FOR HEAVY OIL

#### DESCRIPTION

DESCRIPTION	PART NO.
Kit for heavy oil up to 20°E at 50°C	
BT 300 DSN 4T	98000304
Kit for heavy oil up to 50°E at 50°C	
BT 300 DSPN	98000316
Kit for heavy oil with low sulphur content and max viscosity 15°E at 50°C	
BT 300 DSN 4T	98000309
BT 300 DSPN	98000319

### NOTES

4 Equipped with air closure device.

17 Not including steam regulator.

Net calorific value of heavy oil: Hi = 40,19 MJ/kg = 9600 kcal/kg.

### OPTIONALS

#### DESCRIPTION

Steam pre-heater (17)

BT 300 DSNM-D/300 DSPN: extra heavy oil burner operation max viscosity 100°E at 50°C

### HEAVY OIL BURNER ACCESSORIES

BT 300 DSN 4T: line filter, flex hoses, nozzles, boiler coupling kit.

BT 300 DSNM-D: self-cleaning, line filter with heating element and thermostat, flex hoses, boiler coupling kit.

BT 300 DSPN: line filter, flex hoses, boiler coupling kit.



BT 350 DSN 4T



BT 350 DSN 4T HINGED



BT 350 DSNM-D



BT 350 DSPN

**Heavy oil burner. Operation:**

**Extra heavy oil burner. Operation:**

Continuous modulation operation by installing P.I.D. controller in the control panel (to be ordered separately with modulation probe).

Modulation ratio:

Adjusting the combustion head.

Maintenance facilitated by the possibility of removing the combustion head without having to remove the burner from the boiler.

Fixed boiler coupling flange.

Sliding boiler coupling flange to adapt the blast-pipe to the various types of boilers.

Easy maintenance thanks to the two-sides hinge which allows the removal of the combustion head without having to remove the burner from the boiler.

Combustion air intake with butterfly valve. Air flow adjustment:

Fully closing air damper on shutdown to avoid loss of heat through the chimney.

Electric motor for pump drive.

Fuel supply circuit made of gear pump with pressure adjustment, shut-off valves and maximum pressure switch.

Fuel supply circuit made of gear pump with pressure adjustment, shut-off valves, control flow valve and maximum pressure switch.

Fuel supply circuit made of gear pump with pressure adjustment, control flow valve and maximum pressure switch.

Electric fuel preheater with antigas valve, filter, thermometer, adjustment, minimum and safety thermostats.

Electric fuel preheater with antigas valve, self-cleaning filter, thermometer, adjustment, minimum and safety thermostats.

Atomisation unit with nozzle-closing pin.

Atomisation unit with magnet to control the outlet/nozzle return pins.

Heating element for pump, valve and atomisation unit.

Flame detection by photoresistance.

Electric protection rating:

BT 350 DSN 4T

BT 350 DSN 4T Hinged

BT 350 DSNM-D

BT 350 DSPN

two-stage

two-stage

two-stage

mechanical two-stage progressive

•

1:3

•

•

•

•

•

•

•

•

•

•

•

•

•

•

•

•

•

•

•

•

electric servomotor

electric servomotor

electric servomotor

mechanical cam

•

•

•

•

•

•

•

•

•

•

•

•

•

•

•

•

•

•

•

•

•

•

•

•

•

•

•

•

•

•

•

•

•

•

•

•

•

•

•

•

•

•

•

•

•

•

•

•

IP40

IP40

IP40

IP40

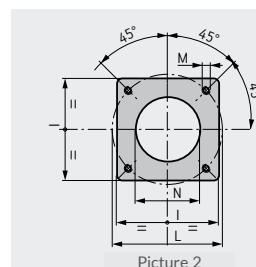
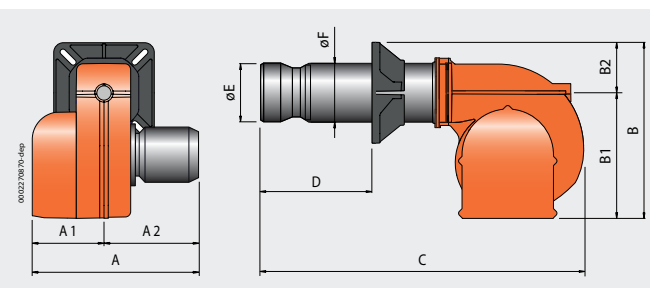

Flange dimensions and boiler drilling template.

Model	A mm	A1 mm	A2 mm	B mm	B1 mm	B2 mm	C mm	D mm	E mm	F mm	I mm	L mm	M mm	N mm	Pic.
BT 350 DSN 4T	1170	645	525	880	660	220	1960	350 ÷ 560	360	275	440	400 ÷ 540	M20	365	2
BT 350 DSN 4T Hinged	1085	560	525	1125	1005	220	1530	420	360	280	430	509	M18	370	2
BT 350 DSNM-D	1220	695	525	880	660	220	1960	350 ÷ 560	360	275	440	400 ÷ 540	M20	365	2
BT 350 DSPN	1220	695	525	880	660	220	1960	350 ÷ 560	360	275	440	400 ÷ 540	M20	365	2

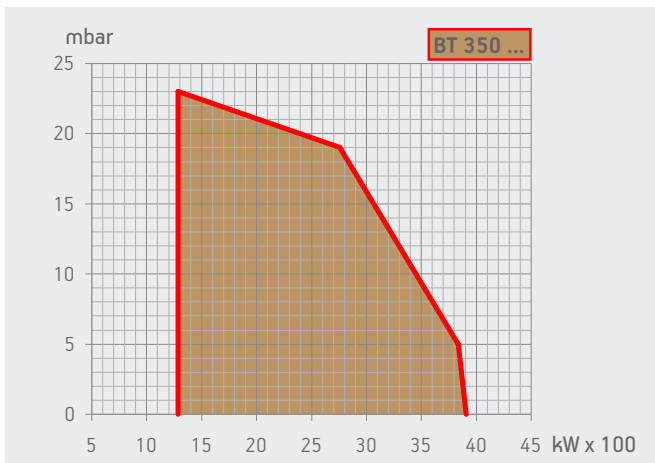

Model	Size of packaging			Weight kg
	L	P mm	H	
BT 350 DSN 4T	2260	1520	1150	420
BT 350 DSN 4T Hinged	1710	1540	1560	420
BT 350 DSNM-D	2260	1520	1150	475
BT 350 DSPN	2260	1520	1150	466

	Thermal output kW	Model	Part no.	Max visc. °E at 50°C	Electrical supply	Motor kW	Tank heating element kW	Notes
Frequency 50 Hz								
1284 ÷ 3907		<b>BT 350 DSN 4T</b>	<b>2121010</b>	7	3N AC 50Hz 400V	9,0	28,5	4)
1284 ÷ 3907		<b>BT 350 DSN 4T Hinged</b>	<b>2121011</b>	7	3N AC 50Hz 400V	9,0	28,5	4)
1284 ÷ 3907		<b>BT 350 DSNM-D</b>	<b>2525010</b>	50	3N AC 50Hz 400V	9,0+2,2	28,5	4)
1284 ÷ 3907		<b>BT 350 DSPN</b>	<b>2640010</b>	7	3N AC 50Hz 400V	9,0+2,2	28,5	4)
Frequency 60 Hz								
1284 ÷ 3907		<b>BT 350 DSN 4T</b>	<b>21215410</b>	7	3N AC 60Hz 380V	11,0+1,3	28,5	4)
1284 ÷ 3907		<b>BT 350 DSN 4T Hinged</b>	<b>21215411</b>	7	3N AC 60Hz 380V	11,0+1,3	28,5	4)
1284 ÷ 3907		<b>BT 350 DSNM-D</b>	<b>25255410</b>	50	3N AC 60Hz 380V	11,0+2,6	28,5	4)
1284 ÷ 3907		<b>BT 350 DSPN</b>	<b>26405410</b>	7	3N AC 60Hz 380V	11,0+2,6	28,5	4)

### TO COMPLETE THE BURNER

#### DESCRIPTION

BT 350 DSNM-D/300 DSPN: nozzle with 1 ÷ 3 ratio (see page 295)

### MODULATING MODE

#### DESCRIPTION

BT 350 DSPN: modulation kit 98000055

BT 350 DSPN: modulating probe (see page 294)

### KIT FOR HEAVY OIL

#### DESCRIPTION

DESCRIPTION	PART NO.
Kit for heavy oil up to 20°E at 50°C	
BT 350 DSN 4T	98000304
Kit for heavy oil up to 50°E at 50°C	
BT 350 DSPN	98000316
Kit for heavy oil with low sulphur content and max viscosity 15°E at 50°C	
BT 350 DSN 4T	98000309
BT 350 DSPN	98000319

### NOTES

4 Equipped with air closure device.

17 Not including steam regulator.

Net calorific value of heavy oil: Hi = 40,19 MJ/kg = 9600 kcal/kg.

### OPTIONALS

#### DESCRIPTION

Steam pre-heater (17)

BT 350 DSNM-D/300 DSPN: extra heavy oil burner operation max viscosity 100°E at 50°C

### HEAVY OIL BURNER ACCESSORIES

BT 350 DSN 4T: line filter, flex hoses, nozzles, boiler coupling kit.

BT 350 DSNM-D: self-cleaning, line filter with heating element and thermostat, flex hoses, boiler coupling kit.

BT 350 DSPN: line filter, flex hoses, boiler coupling kit.





### Extra heavy oil burner. Operation:

Continuous modulation operation by installing P.I.D. controller in the control panel (to be ordered separately with modulation probe).

Modulation ratio:

Adjusting the combustion head.

Maintenance facilitated by the possibility of removing the combustion head without having to remove the burner from the boiler.

Sliding boiler coupling flange to adapt the blast-pipe to the various types of boilers.

Combustion air intake with butterfly valve. Air flow adjustment:

Fully closing air damper on shutdown to avoid loss of heat through the chimney.

Electric motor for pump drive.

Fuel supply circuit made of gear pump with pressure adjustment, control flow valve and maximum pressure switch.

Electric fuel preheater with antigas valve, self-cleaning filter, thermometer, adjustment, minimum and safety thermostats.

Atomisation unit with magnet to control the outlet/nozzle return pins.

Heating element for pump, valve and atomisation unit.

Flame detection by photoresistance.

Electric protection rating:

	GI 350 DSPN-D	GI 420 DSPN-D	GI 510 DSPN-D
	mechanical two-stage progressive	mechanical two-stage progressive	mechanical two-stage progressive
Continuous modulation operation by installing P.I.D. controller in the control panel (to be ordered separately with modulation probe).	•	•	•
Modulation ratio:	1:3	1:3	1:3
Adjusting the combustion head.	•	•	•
Maintenance facilitated by the possibility of removing the combustion head without having to remove the burner from the boiler.	•	•	•
Sliding boiler coupling flange to adapt the blast-pipe to the various types of boilers.	•	•	•
Combustion air intake with butterfly valve. Air flow adjustment:	mechanical cam	mechanical cam	mechanical cam
Fully closing air damper on shutdown to avoid loss of heat through the chimney.	•	•	•
Electric motor for pump drive.	•	•	•
Fuel supply circuit made of gear pump with pressure adjustment, control flow valve and maximum pressure switch.	•	•	•
Electric fuel preheater with antigas valve, self-cleaning filter, thermometer, adjustment, minimum and safety thermostats.	•	•	•
Atomisation unit with magnet to control the outlet/nozzle return pins.	•	•	•
Heating element for pump, valve and atomisation unit.	•	•	•
Flame detection by photoresistance.	•	•	•
Electric protection rating:	IP40	IP40	IP40

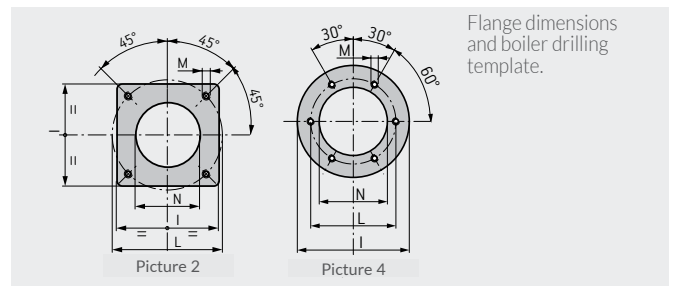
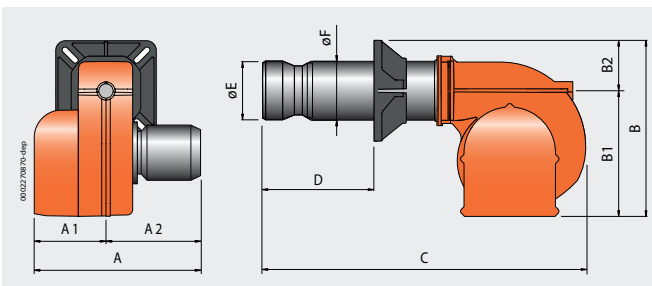

Model	A mm	A1 mm	A2 mm	B mm	B1 mm	B2 mm	C mm	D mm	E mm	F mm	I mm	L mm	M mm	N mm	Pic.
GI 350 DSPN-D	1345	660	685	970	750	220	1900	275 ÷ 500	360	275	440	400 ÷ 540	M20	365	2
GI 420 DSPN-D	1345	660	685	1040	750	290	2030	275 ÷ 500	400	355	580	520	M20	420	4
GI 510 DSPN-D	1345	660	685	1040	750	290	2030	275 ÷ 500	400	355	580	520	M20	420	4

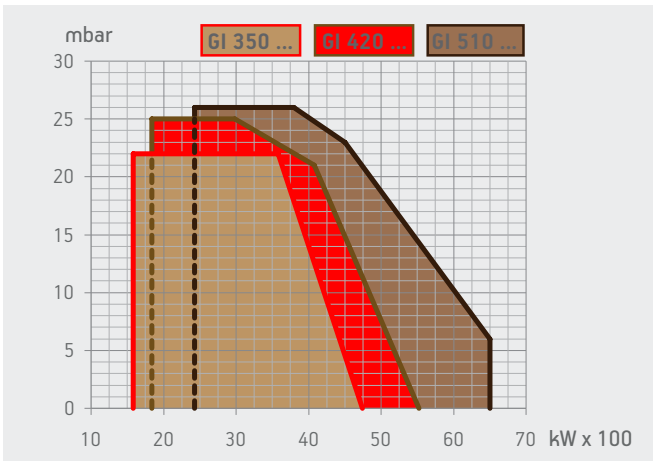

Model	Size of packaging			Weight kg
	L	P mm	H	
GI 350 DSPN-D	2260	1520	1150	578
GI 420 DSPN-D	2260	1520	1150	672
GI 510 DSPN-D	2260	1520	1150	704

	Thermal output kW	Model	Part no.	Max visc. °E at 50°C	Electrical supply	Motor kW	Tank heating element kW	Notes
Frequency 50 Hz								
	1581 ÷ 4743	<b>GI 350 DSPN-D</b>	<b>6533010</b>	50	3N AC 50Hz 400V	15,0+2,2	28,5	4)
	1840 ÷ 5522	<b>GI 420 DSPN-D</b>	<b>6538010</b>	50	3N AC 50Hz 400V	18,5+3,0	28,5	4)
	2430 ÷ 6500	<b>GI 510 DSPN-D</b>	<b>6543010</b>	50	3N AC 50Hz 400V	18,5+3,0	28,5	4)
Frequency 60 Hz								
	1581 ÷ 4743	<b>GI 350 DSPN-D</b>	<b>65335410</b>	50	3N AC 60Hz 380V	11,0+2,6	28,5	4)
	1840 ÷ 5522	<b>GI 420 DSPN-D</b>	<b>65385410</b>	50	3N AC 60Hz 380V	13,0+3,5	28,5	4)
	2430 ÷ 6500	<b>GI 510 DSPN-D</b>	<b>65435410</b>	50	3N AC 60Hz 380V	22,0+3,5	28,5	4)

## TO COMPLETE THE BURNER

### DESCRIPTION

Nozzle with 1 ÷ 3 ratio (see page 295)

## MODULATING MODE

### DESCRIPTION

Modulation kit

### PART NO.

98000055

Modulating probe (see page 294)

## OPTIONALS

### DESCRIPTION

Steam pre-heater (17)

Extra heavy oil burner operation max viscosity 100°E at 50°C

## HEAVY OIL BURNER ACCESSORIES

Self-cleaning, line filter with heating element and thermostat, flex hoses, boiler coupling kit.

## NOTES

4 Equipped with air closure device.

17 Not including steam regulator.

Net calorific value of heavy oil: Hi = 40,19 MJ/kg = 9600 kcal/kg.



### GI 1000 DSPN-D

#### mechanical two-stage progressive

<b>Extra heavy oil burner. Operation:</b>	
Continuous modulation operation by installing P.I.D. controller in the control panel (to be ordered separately with modulation probe).	•
Modulation ratio:	1:4
Adjusting the combustion head.	•
Maintenance facilitated by the possibility of removing the combustion head without having to remove the burner from the boiler.	•
Fixed boiler coupling flange.	•
Easy maintenance thanks to the two-sides hinge which allows the removal of the combustion head without having to remove the burner from the boiler.	•
Combustion air intake with butterfly valve. Air flow adjustment:	mechanical cam
Fully closing air damper on shutdown to avoid loss of heat through the chimney.	•
Electric motor for pump drive.	•
Fuel supply circuit made of gear pump with pressure adjustment, control flow valve and maximum pressure switch.	•
Electric fuel preheater with antigas valve, self-cleaning filter, thermometer, minimum and safety thermostats, electronic temperature regulator.	•
Atomisation unit with magnet to control the outlet/nozzle return pins.	•
Heating element for pump, valve and atomisation unit.	•
Ignition gas train complete with operation and safety valve, min. pressure switch, pressure regulator and gas filter.	•
Flame detection by UV photocell.	•
Electric protection rating:	IP40

HEAVY OIL

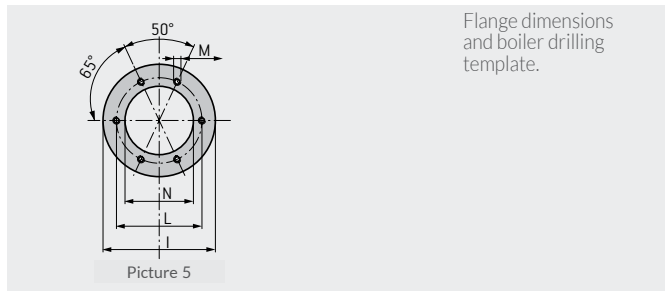
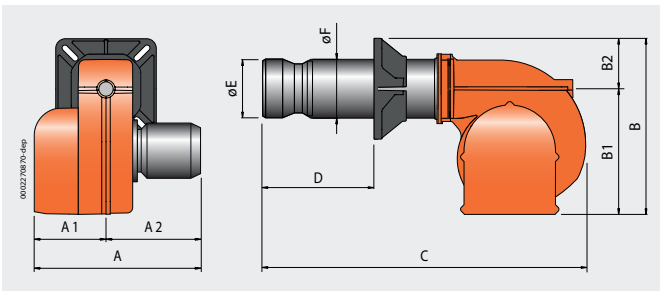

Flange dimensions and boiler drilling template.

Model	A mm	A1 mm	A2 mm	B mm	B1 mm	B2 mm	C mm	D mm	E mm	F mm	I mm	L mm	M mm	N mm	Pic.
GI 1000 DSPN-D	1465	800	665	1260	855	405	1960	430	480	490	800	765	M16	495	5

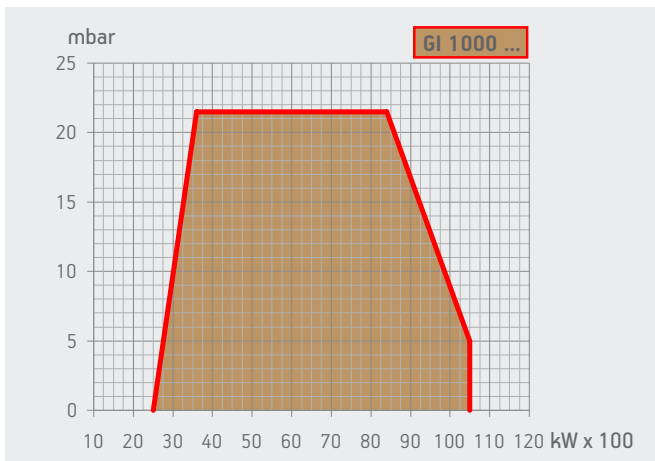

Model	Size of packaging			Weight kg
	L	P mm	H	
GI 1000 DSPN-D	2610	1760	1470	1040

Thermal output kW	Model	Part no.	Max visc. °E at 50°C	Electrical supply	Motor kW	Tank heating element kW	Notes
2500 ÷ 10500	GI 1000 DSPN-D	6553010	50	3N AC 50Hz 400V	22,0+4,0	40	4) 13)
	Frequency 60 Hz						
2500 ÷ 10500	GI 1000 DSPN-D	65535410	50	3N AC 60Hz 380V	30,0+3,5	40	4) 13)

### TO COMPLETE THE BURNER

DESCRIPTION
Nozzle with 1 ÷ 5 ratio (see page 295)

### MODULATING MODE

DESCRIPTION	PART NO.
Modulation kit	98000055
Modulating probe (see page 294)	

### OPTIONALS

DESCRIPTION
Steam pre-heater (17)
Extra heavy oil burner operation max viscosity 100°E at 50°C

### HEAVY OIL BURNER ACCESSORIES

Self-cleaning, line filter with heating element and thermostat, flex hoses, boiler coupling kit.

### NOTES

- 4 Equipped with air closure device.
  - 13 Electric fuel pre-heater supplied separately, not on board machine.
  - 17 Not including steam regulator.
- Net calorific value of heavy oil: Hi = 40,19 MJ/kg = 9600 kcal/kg.



## Characteristics

Burners made up from separate components such as combustion heads, fan units, electrical panels, pumping units and gas valves to be placed and connected on site according to the technical specifications required by the plant.

Such technical solution grants the highest flexibility so as to satisfy all the installing needs requested by an industrial market which keeps on developing.

The most usual applications are big plants with water pipe boilers, smoke passes boilers, diatermic boilers, drying plants, melting ovens and , generally speaking, industrial process.

IB series is available either with mechanical or electronic cam.

The whole series is made up of 8 models whose working field ranges from 0,5 MW to 24 MW.

## Symbols

IB...G

Modulating gas burner with separate fan.

## Plus

### LOW NO<sub>x</sub> AND CO EMISSIONS

The new combustion head drawing grant to recirculate part of the exhausts. This new design and technology enable, while running with natural gas, to respect the Class III Low Nox according to EN676.

### ENERGY SAVING

The electronic version, keeping on controlling the unburnt level (CO) in the combustion, enables to sensibly increase the efficiency.

Using such technology in addition to the inverter to optimize the necessary quantity of combusting air, grant to reduce either the electrical consumption of the fan motor and the noisy level, too.

### EASY MAINTENANCE

Maintenance is easy and takes short time . By taking out the cover, the access to the mixing head and to the internal components is fully granted.

### COMBUSTION AIR TEMPERATURE

Standard version is up to 100°C.

Special version is up to 250°C.

### AIR INTAKE POINT

The air intake point can be from the top, from the bottom, from right or from left side.

IB gas operating range

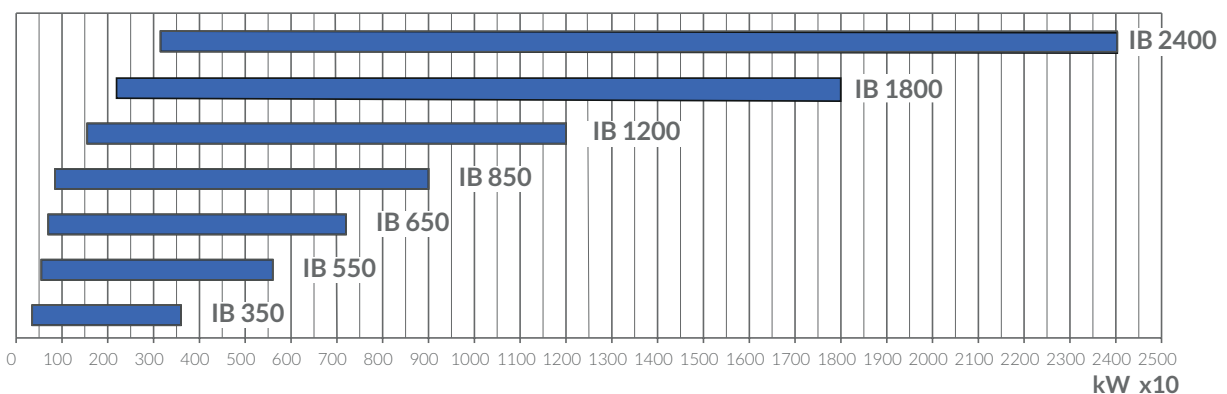

Test conditions conform to EN 267 and EN 676: Temperature: 20°C; Barometric pressure: 1013.5 mbar.

For further information see the specific manuals.

Estimates may be obtained from Baltur's sales or assistance networks or directly from the sales office.



## Characteristics

Burners made up from separate components such as combustion heads, fan units, electrical panels, pumping units and gas valves to be placed and connected on site according to the technical specifications required by the plant.

## Symbols

### TS... L

Modulating light oil burner with separate fan.

### TS...N-D

Modulating heavy oil burner with separate fan.

### TS...GL

Dual fuel gas/light oil modulating burner with separate fan.

### TS...GN-D

Dual fuel gas/heavy oil modulating burner with separate fan.

## Fuels

- Light oil, maximum viscosity 6,2 cSt (1.5°E) at 20°C.
- Heavy oil, maximum viscosity 460 cSt (60°E) at 50°C.
- Dual fuel gas/light oil, light oil with maximum viscosity of 6,2 cSt (1.5°E) at 20°C and natural gas (G20) at 150 to 450 mbar pressure. Please contact our sales offices for different types of gas and pressures.
- Dual fuel gas/heavy oil, heavy oil with maximum viscosity of 460 cSt (60°E) at 50°C and natural gas (G20) at 150 to 450 mbar pressure. Please contact our sales offices for different types of gas and pressures.

## Combustion air temperature

- Combustion air temperature up to 60°C. Special execution for temperatures up to 200°C (version ...AC).

TS operating range combustion air temperature 20°C

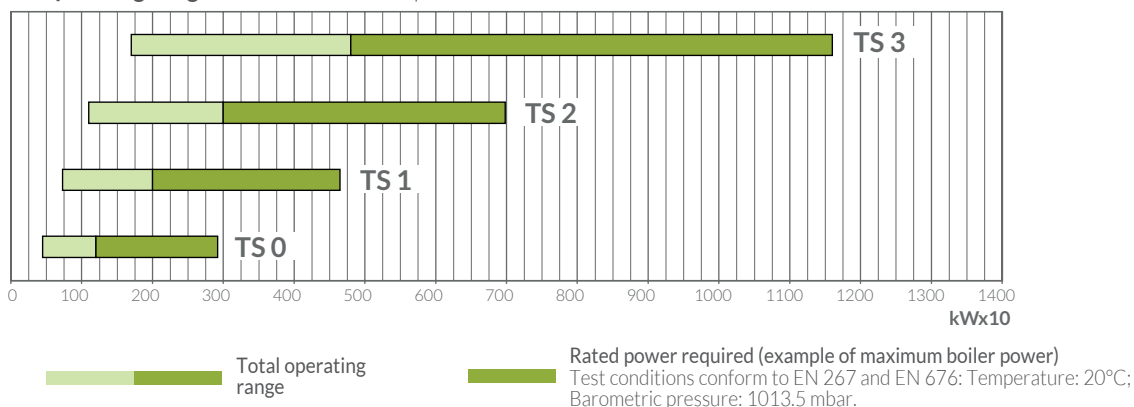

For further information see the specific manuals.

Estimates may be obtained from Baltur's sales or assistance networks or directly from the sales office.

The two stage progressive burners, by installing the PID load controller and related modulating kit, can operate as modulating burners with the ability to adjust the thermic load according to boiler needs.

The load adjustment is possible between the minimum and maximum burner's operating point.

### How to choose the modulating kit components:

According to the parameter that it's necessary to control: temperature (°C) or pressure (bar) it's necessary to choose the range kit according to boiler operating

range.

In case the value is included in two ranges it's necessary to select the lower range.

### Example:

In case the required hot water boiler set point is 100°C it's necessary to select the temperature probe kit with operating range between 0 ÷ 130°C.

In case the steam boiler must operate with 8bar outlet steam pressure it's necessary to select the pressure probe kit with operating range between 0 ÷ 10 bar.



### Automatic proportional modulation regulator PID

Part no.	Model
98000055	Modulation kit LC3
98000056	Modulation kit LC3
98000057	Modulation kit LC3
98000058	Modulation kit LC3
98000059	Modulation kit LCM 100

### Temperature probe for LC3 modulation

Part no.	Temperature	Type robe	Probe length	Male coupling
98000023	0 °C ÷ 130 °C	PT 1000	85 <sup>1)</sup>	R 1/2"
98000021	0 °C ÷ 500 °C	PT 1000	200 <sup>1)</sup>	G 1/2"
98000022	0 °C ÷ 1100 °C	Thermocouple	425 <sup>1)</sup>	R 1/2"

### Temperature probe for LCM 100 modulation

Part no.	Temperature	Type robe	Probe length	Male coupling
98000023	0 °C ÷ 130 °C	PT 1000	85 <sup>1)</sup>	R 1/2"
98000021	0 °C ÷ 500 °C	PT 1000	200 <sup>1)</sup>	G 1/2"

### Temperature probe for ETAMATIC OEM control box

Part no.	Temperature	Type robe	Probe length	Male coupling
98000035	0 °C ÷ 500 °C	PT 100	100 <sup>1)</sup>	G 1/2"

### Steam pressure probe (for all types of automatic regulator)\*

Part no.	Pressure steam	Signal output	Male coupling
98000045	0 ÷ 1 bar	4 ÷ 20 mA	G 1/2"
98000046	0 ÷ 10 bar	4 ÷ 20 mA	G 1/2"
98000047	0 ÷ 16 bar	4 ÷ 20 mA	G 1/2"
98000048	0 ÷ 25 bar	4 ÷ 20 mA	G 1/2"
98000049	0 ÷ 40 bar	4 ÷ 20 mA	G 1/2"

\*) In the case of using pressure applications where temperatures exceed 90 ° you need to match the curl kit codes : 98000062

### External climate regulation

Part no.	Description	Temperature
85060070	Temperature probe PT100	-50 °C ÷ 90 °C
98000061	Interface module for LC3	

### Power signal converter (version ...MC and ...PN)

Part no.	Description
98000063	Converter kit 0 ÷ 10 V / 4 ÷ 20 mA

NOTES: For different modulation values please contact our Technical Assistance Service. 1) Different lengths on request.

## RETURN NOZZLES

Nozzle with fuel return for diesel and mixed series two-stage progressive / modulating and modulating burners. This kind of nozzle, while keeping the pump pressure constant, varies the amount of fuel supplied according to the return pressure of the nozzle.

To be ordered together with the burner when placing the order according to the power required by the application.

### Nozzles for light oil and heavy oil (ratio 1÷3)

excluded burners: TBML 350-600-800, GI 1000 and GI MIST 1000.

Part no.	Rated flow-rate kg/h	Flow-rate angle	Codice	Rated flow-rate kg/h	Flow-rate angle
98000201	50	45°	98000218	400	45°
98000202	60	45°	98000219	425	45°
98000203	70	45°	98000220	450	45°
98000204	80	45°	98000221	475	45°
98000205	90	45°	98000222	500	45°
98000206	100	45°	98000223	525	45°
98000207	125	45°	98000224	550	45°
98000208	150	45°	98000225	575	45°
98000209	175	45°	98000226	600	45°
98000210	200	45°	98000227	650	45°
98000211	225	45°	98000228	700	45°
98000212	250	45°	98000229	750	45°
98000213	275	45°	98000230	800	45°
98000214	300	45°	98000231	850	45°
98000215	325	45°	98000232	900	45°
98000216	350	45°	98000233	1000	45°
98000217	375	45°			



### Nozzles for light oil and heavy oil (ratio 1÷5)

for burners TBML 350/600/800.

Part no.	Rated flow-rate kg/h	Flow-rate angle	Part no.	Rated flow-rate kg/h	Flow-rate angle
98000238	200	45°	98000249	475	45°
98000239	225	45°	98000250	500	45°
98000240	250	45°	98000251	525	45°
98000241	275	45°	98000252	550	45°
98000242	300	45°	98000253	575	45°
98000243	325	45°	98000254	600	45°
98000244	350	45°	98000255	650	45°
98000245	375	45°	98000256	700	45°
98000246	400	45°	98000257	750	45°
98000247	425	45°	98000258	800	45°
98000248	450	45°			



for burners GI 1000 e GI MIST 1000

Part no.	Rated flow-rate kg/h	Flow-rate angle	Part no.	Rated flow-rate kg/h	Flow-rate angle
98000280	700	45°	98000283	850	45°
98000281	750	45°	98000284	900	45°
98000282	800	45°	98000285	1000	45°



**Gas pressure regulator with incorporated filter approved CE\***

Control closing , pressure taps upstream side - the side valley , safety diaphragm.  
Max inlet pressure : 1 bar.



Part no.	Model	Outlet pressure mbar	Gas connection
97392010	BTFR/1	40 ÷ 110	1/2"
97392020	BTFR/1	40 ÷ 110	3/4"
97392030	BTFR/1	40 ÷ 110	1"
97392040	BTFR/1	90 ÷ 190	1"1/4
97392050	BTFR/1	90 ÷ 190	1"1/2
97392060	BTFR/1	90 ÷ 190	2"
97392070	BTFR/1	110 ÷ 200	DN65 - PN16
97392080	BTFR/1	110 ÷ 200	DN80 - PN16
97392090	BTFR/1	130 ÷ 200	DN100 - PN16

**CE gas pressure regulator CE\***

Control closing , pressure taps upstream side - the side valley , safety diaphragm.  
Max inlet pressure : 1 bar.



Part no.	Model	Outlet pressure mbar	Gas connection
97392100	BTR/1	100 ÷ 250	DN125 - PN16
97392110	BTR/1	100 ÷ 250	DN150 - PN16

**Gas pressure regulator with incorporated filter approved CE\***

Control closing , pressure taps upstream side - the side valley , safety diaphragm.  
Max inlet pressure : 2 bar.



Part no.	Model	Outlet pressure mbar	Gas connection
97392210	BTFR/2	40 ÷ 110	1/2"
97392220	BTFR/2	40 ÷ 110	3/4"
97392230	BTFR/2	40 ÷ 110	1"
97392240	BTFR/2	90 ÷ 190	1"1/4
97392250	BTFR/2	90 ÷ 190	1"1/2
97392260	BTFR/2	90 ÷ 190	2"
97392270	BTFR/2	110 ÷ 200	DN65 - PN16
97392280	BTFR/2	110 ÷ 200	DN80 - PN16
97392290	BTFR/2	130 ÷ 200	DN100 - PN16

**Gas pressure regulator with incorporated filter approved CE\***

Control closing , pressure taps upstream side - the side valley , safety diaphragm.  
Max inlet pressure : 6 bar.



Part no.	Model	Outlet pressure mbar	Gas connection
97392310	BTFR/6	30 ÷ 90	1/2"
97392320	BTFR/6	30 ÷ 90	3/4"
97392330	BTFR/6	30 ÷ 90	1"

**CE gas pressure regulator CE\***

Control closing , pressure taps upstream side - the side valley , safety diaphragm.  
Max inlet pressure : 6 bar.



Part no.	Model	Outlet pressure mbar	Gas connection
97392340	BTR/6	85 ÷ 180	1"1/4
97392350	BTR/6	85 ÷ 180	1"1/2
97392360	BTR/6	85 ÷ 180	2"
97392370	BTR/6	110 ÷ 200	DN65 - PN16
97392380	BTR/6	110 ÷ 200	DN80 - PN16
97392390	BTR/6	110 ÷ 200	DN100 - PN16

\*) All the pressure regulators in these pages have a standard spring with its own adjustment field For different delivery pressures, the able below shows the regulation field that must be used, as well as the corresponding spring to replace the standard one with.

**PRESSURE REGULATOR SPRINGS**

		1/2"	3/4"	1"	1"1/4	1"1/2	2"	DN 65	DN 80	DN 100	DN 125	DN 150							
PRESSURE INPUT 1bar	regulator code	97392010	97392020	97392030	97392040	97392050	97392060	97392070	97392080	97392090	97392100	97392110							
	code spring	97399002	97399005	97399007	97399008	97399009	97399010	97399011	97399012	97399013	97399014	97399015	97399016	97399017	97399018	97399019	97399020	97399021	97399022
		9 ÷ 28	9 ÷ 28	9 ÷ 28															
		18 ÷ 40	18 ÷ 40	18 ÷ 40															
					13 ÷ 23	13 ÷ 23	13 ÷ 23												
		<b>40 ÷ 110*</b>	<b>40 ÷ 110*</b>	<b>40 ÷ 110*</b>															
					20 ÷ 36	20 ÷ 36	20 ÷ 36												
		110 ÷ 150	110 ÷ 150	110 ÷ 150															
		150 ÷ 200	150 ÷ 200	150 ÷ 200	33 ÷ 58	33 ÷ 58	33 ÷ 58												
					55 ÷ 100	55 ÷ 100	55 ÷ 100												
									13 ÷ 27	13 ÷ 27	15 ÷ 27								
									22 ÷ 50	22 ÷ 50	22 ÷ 55								
		200 ÷ 600	200 ÷ 600	200 ÷ 600															
					<b>90 ÷ 190*</b>	<b>90 ÷ 190*</b>	<b>90 ÷ 190*</b>												
									50 ÷ 130	50 ÷ 130	55 ÷ 130								
								<b>110 ÷ 200*</b>	<b>110 ÷ 200*</b>	<b>130 ÷ 200*</b>									
											20 ÷ 150	20 ÷ 150							
											<b>100 ÷ 250*</b>	<b>100 ÷ 250*</b>							
											230 ÷ 350	230 ÷ 350							
											300 ÷ 450	300 ÷ 450							
PRESSURE INPUT 2 bar	regulator code	97392210	97392220	97392230	97392240	97392250	97392260	97392270	97392280	97392290									
	code spring	97399001	97399005	97399008	97399010	97399011	97399012	97399013	97399014	97399015	97399016	97399017	97399018						
		9 ÷ 22	9 ÷ 22	9 ÷ 22															
		20 ÷ 40	20 ÷ 40	20 ÷ 40															
		<b>40 ÷ 110*</b>	<b>40 ÷ 110*</b>	<b>40 ÷ 110*</b>	12 ÷ 35	12 ÷ 35	12 ÷ 35												
		110 ÷ 150	110 ÷ 150	110 ÷ 150	30 ÷ 50	30 ÷ 50	30 ÷ 50												
		150 ÷ 200	150 ÷ 200	150 ÷ 200	40 ÷ 60	40 ÷ 60	40 ÷ 60												
					60 ÷ 95	60 ÷ 95	60 ÷ 95												
									13 ÷ 27	13 ÷ 27	15 ÷ 27								
									22 ÷ 50	22 ÷ 50	27 ÷ 55								
	200 ÷ 600	200 ÷ 600	200 ÷ 600																
				<b>90 ÷ 190*</b>	<b>90 ÷ 190*</b>	<b>90 ÷ 190*</b>													
								50 ÷ 130	50 ÷ 130	55 ÷ 130									
								<b>110 ÷ 200*</b>	<b>110 ÷ 200*</b>	<b>130 ÷ 200*</b>									
PRESSURE INPUT 6 bar	regulator code	97392310	97392320	97392330	97392340	97382350	97392360	97392370	97392380	97392390									
	code spring	97399003	97399004	97399006	97399009	97399011	97399012	97399013	97399014	97399016	97399017	97399018							
		20 ÷ 30	20 ÷ 30	20 ÷ 30															
		<b>30 ÷ 90*</b>	<b>30 ÷ 90*</b>	<b>30 ÷ 90*</b>															
		90 ÷ 170	90 ÷ 170	90 ÷ 170															
					15 ÷ 33	15 ÷ 33	15 ÷ 33												
					32 ÷ 60	32 ÷ 60	32 ÷ 60												
					50 ÷ 95	50 ÷ 95	50 ÷ 95												
									13 ÷ 27	13 ÷ 27	13 ÷ 22								
									22 ÷ 58	22 ÷ 58	18 ÷ 40								
				<b>85 ÷ 180*</b>	<b>85 ÷ 180*</b>	<b>85 ÷ 180*</b>													
								50 ÷ 130	50 ÷ 130	25 ÷ 120									
								<b>110 ÷ 200*</b>	<b>110 ÷ 200*</b>	<b>110 ÷ 200*</b>									

\*) of series.

**SPRINGS FOR PRESSURE REGULATOR**

Part no.	Type	Part no.	Type
97399001	Regulator spring M0-0400	97399012	Regulator spring M0-1000
97399002	Regulator spring M0-0402	97399013	Regulator spring M0-1100
97399003	Regulator spring M0-0410	97399014	Regulator spring M0-1200
97399004	Regulator spring M0-0440	97399015	Regulator spring M0-1305
97399005	Regulator spring M0-0500	97399016	Regulator spring M0-1370
97399006	Regulator spring M0-0520	97399017	Regulator spring M0-1400
97399007	Regulator spring M0-0800	97399018	Regulator spring M0-1400/1800
97399008	Regulator spring M0-0825	97399019	Regulator spring M0-8400
97399009	Regulator spring M0-0850	97399020	Regulator spring M0-8500
97399010	Regulator spring M0-0900	97399021	Regulator spring M0-8600
97399011	Regulator spring M0-0970	97399022	Regulator spring M0-8700

**Gas filters approved CE**

With pressure.

Max inlet pressure: 2 bar.



Part no.	Model	Gas connection
97410001	BTF	1/2" FF
97410002	BTF	3/4" FF
97410003	BTF	1" FF
97410004	BTF	1" 1/4 FF
97410005	BTF	1" 1/2 FF
97410006	BTF	2" FF
97419999	BTF	DN65 - PN16
97429999	BTF	DN80 - PN16
97439999	BTF	DN100 - PN16
97459999	BTF	DN125 - PN16
97449999	BTF	DN150 - PN16

**Gas filters approved CE**

With pressure.

Max inlet pressure: 6 bar.



Part no.	Model	Gas connection
97410010	BTF/6	1" 1/4" FF
97410011	BTF/6	1" 1/2" FF
97410012	BTF/6	2" FF
97410013	BTF/6	DN65 - PN16
97410014	BTF/6	DN80 - PN16
97410015	BTF/6	DN100 - PN16

**Anti-vibration and compensation joints approved CE**

DIN 30681 stainless steel.

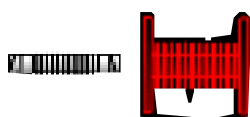

Part no.	Model	Gas connection
97029999	BTGA	1/2" MM
97039999	BTGA	3/4" MM
97049999	BTGA	1" MM
97059999	BTGA	1" 1/4" MM
97069999	BTGA	1" 1/2" MM
97079999	BTGA	2" MM
97089999	BTGA	DN65 - PN16
97099999	BTGA	DN80 - PN16
97109999	BTGA	DN100 - PN16
97119999	BTGA	DN125 - PN16
97129999	BTGA	DN150 - PN16

**Ball valves approved CE**



Part no.	Model	Gas connection
97679999	BTVS	3/8" FF
97689999	BTVS	1/2" FF
97699999	BTVS	3/4" FF
97709999	BTVS	1" FF
97719999	BTVS	1" 1/4" FF
97729999	BTVS	1" 1/2" FF
97739999	BTVS	2" FF
97749999	BTVS	DN65 - PN16
97759999	BTVS	DN80 - PN16
97769999	BTVS	DN100 - PN16
97179999	BTVS	DN125 - PN16
97189999	BTVS	DN150 - PN16

# SOUNDPROOF BURNER

Average sound pressure reduction of about 10 dB(A) measured in a laboratory with 1 meter microphone from the burner.

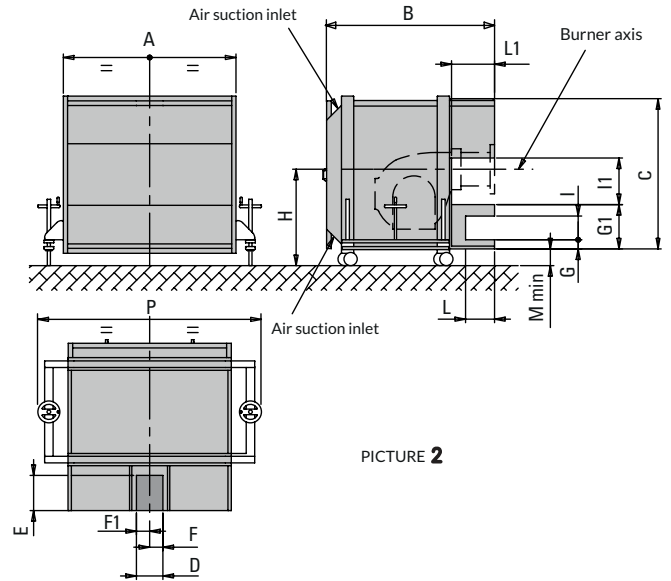
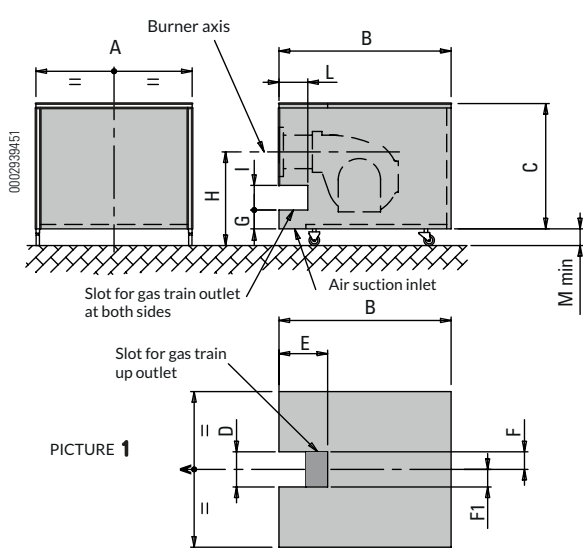

Model	Sound pressure	Pic.	A mm	B mm	C mm	D mm	E mm	F mm	F1 mm	G mm	G1 mm	H mm		I mm	I1 mm	L mm	L1 mm	M min mm	P mm
												min	max						
97980053*	-10 dB(A)	1	1100	1340	860	85	500	42,5	42,5	207	-	660	1350	85	-	500	-	190	-
97980054	-10 dB(A)	1	750	1080	650	85	380	42,5	42,5	157	-	560	1060	85	-	355	-	190	-
97980055	-10 dB(A)	1	1100	1340	860	85	440	42,5	42,5	-	-	650	1300	-	-	-	-	190	-
97980057	-10 dB(A)	1	1335	1655	1130	210	495	47,5	162,5	-	-	900	1700	-	-	-	-	190	-
97980058*	-10 dB(A)	1	1610	1740	1190	500	380	37,5	462,5	24,5	-	950	1700	210	-	380	-	190	-
97980061	-20 dB(A)	2	1956	1945	1740	300	400	150	150	104	504	1450	1700	270	530	330	490	180	2540
97980063	-20 dB(A)	2	2180	2000	1830	300	400	150	150	100	500	1450	1700	270	530	330	490	195	2700

## NOTES:

For gas burners in case of gas train up outlet it is necessary to install a 200 mm long cilindric extension.

\*) To decrease the sound pressure by 20 dB(A) please contact our sales office.

# GAS TRAIN STRUCTURE AND COMPOSITION

## B2

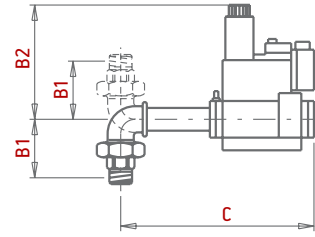
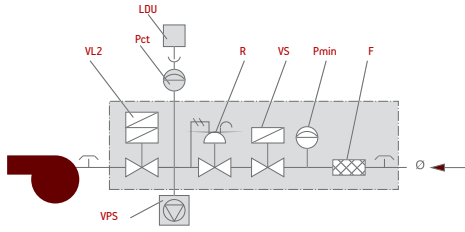

Gas train Part no.	Position									Gas train dimensions mm			Size of packaging mm	Weight kg
	F	LDU	Pct	Pmin	R	VL2	VPS	VS	Ø	B1	B2	C	L x P x H	
19990016 (MB... 405 - 1/2")	●			●	●	●	■	●	3/4"	72	210	204	300 x 210 x 300	5
19990020 (MB... 407 - 3/4")	●			●	●	●	■	●	3/4"	72	210	204	300 x 210 x 300	5
19990024 (MB... 410 - 1")	●			●	●	●	■	●	1"1/4	95	260	249	300 x 210 x 300	8
19990168 (MB... 412 - 1"1/4)	●			●	●	●	■	●	1"1/4	95	260	249	300 x 210 x 300	8
19990404 (MB... 415 - 1"1/2)	●			●	●	●		●	1"1/2	103	270	311	520 x 410 x 410	11
19990410 (MB... 412 - 1"1/4)	●			●	●	●		●	1"1/4	103	260	255	300 x 210 x 300	9
19990454 (MB... 415 - 1"1/2)	●	●	●	●	●	●		●	1"1/2	103	270	311	520 x 410 x 410	12
19990510 (MB... 407 - 3/4")	●			●	●	●	■	●	3/4"	72	210	365	300 x 210 x 300	5
19990511 (MB... 410 - 1")	●			●	●	●	■	●	1"1/4	95	260	410	300 x 210 x 300	8
19990512 (MB... 412 - 1"1/4)	●			●	●	●	■	●	1"1/4	95	260	410	300 x 210 x 300	8
19990513 (MB... 415 - 1"1/2)	●			●	●	●	■	●	1"1/2	103	270	500	460 x 250 x 460	11
19990514 (MB... 420 - 2")	●			●	●	●	■	●	2"	114	330	500	520 x 410 x 410	13

## B4

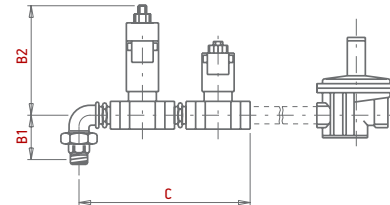
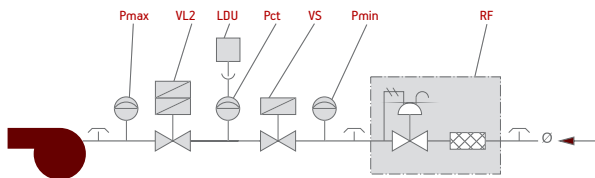

Gas train Part no.	Position								Gas train dimensions mm			Size of packaging mm	Weight kg
	LDU	Pct	Pmax	Pmin	RF	VL2	VS	Ø	B1	B2	C	L x P x H	
19990456			●	●	DN65	2"	2"	DN65	114	305	454	520 x 410 x 410	20
19990457	●	●	●	●	DN65	2"	2"	DN65	114	305	454	650 x 500 x 380	21
19990459	●	●	●	●	DN65	2"		DN65	114	305	682	830 x 430 x 640	40

**CTV** Valve tightness control.  
**F** Filter.  
**LDU** LDU valve tightness control.  
**Pct** Pressure switch for gas control.  
**Pmax** Maximum pressure switch.  
**Pmc** Minimum and control pressure switch gas leaks.  
**Pmin** Minimum pressure switch.  
**R** Pressure regulator.  
**RF** Pressure regulator with filter.

**RFP** Pressure regulator with filter for pilot gas train.  
**RM** Manual flow rate regulator.  
**RP** Pneumatic regulator.  
**VF** Regulator throttle valve.  
**VL** Operating valve.  
**VL2** Two-stage operating valve.  
**VLP** Operating pilot valve.  
**VLR** Operating valve with pressure regulator.

**VP** Pilot valve.  
**VPS** VPS valve tightness control.  
**VS** Safety valve.  
**VSP** Safety pilot valve.  
**Ø** Gas train diameter.  
**Ø1** Main gas train diameter.  
**Ø2** Pilot gas train diameter.

● As standard.  
 ▲ As standard for burners with an output of more than 1200 kW, on request for burners with an output of less than 1200 kW.  
 ■ On request.  
 ◆ Mounted on burner.

# GAS TRAIN STRUCTURE AND COMPOSITION

## BE4

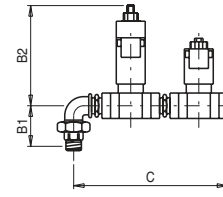
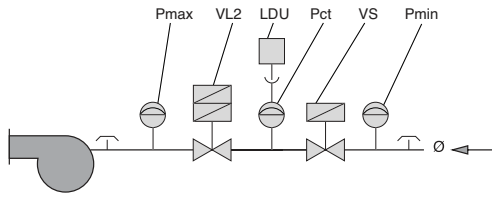

Gas train Part no.	Position							Gas train dimensions mm			Size of packaging mm	Weight
	LDU	Pct	Pmax	Pmin	VL2	VS	Ø	B1	B2	C	L x P x H	kg
19990456			●	●	2"	2"	2"	114	305	454	520 x 410 x 410	20
19990457	●	●	●	●	2"	2"	2"	114	305	454	650 x 500 x 380	21
19990458			●	●	2"	DN65	DN65	114	305	682	830 x 430 x 640	36
19990459	●	●	●	●	2"	DN65	DN65	114	305	682	830 x 430 x 640	40

## B5

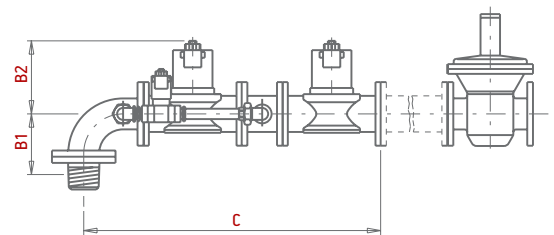
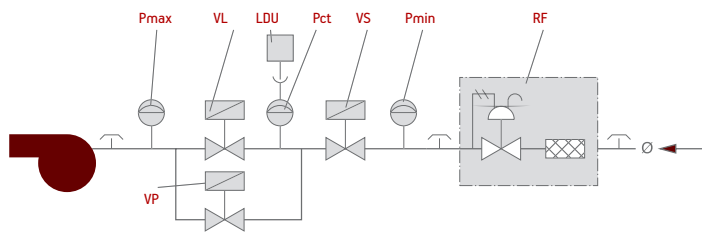

Gas train Part no.	Position							Gas train dimensions mm			Size of packaging mm	Weight	
	LDU	Pct	Pmax	Pmin	RF	VL	VP	Ø	B1	B2	C	L x P x H	kg
19990461	●	●	●	●	DN65	DN65	DN65	DN65	207	295	969	1260 x 650 x 670	64
19990463	●	●	●	●	DN80	DN80	DN65	DN80	210	320	1016	1260 x 650 x 670	98

**CTV** Valve tightness control.  
**F** Filter.  
**LDU** LDU valve tightness control.  
**Pct** Pressure switch for gas control.  
**Pmax** Maximum pressure switch.  
**Pmc** Minimum and control pressure switch gas leaks.  
**Pmin** Minimum pressure switch.  
**R** Pressure regulator.  
**RF** Pressure regulator with filter.

**RFP** Pressure regulator with filter for pilot gas train.  
**RM** Manual flow rate regulator.  
**RP** Pneumatic regulator.  
**VF** Regulator throttle valve.  
**VL** Operating valve.  
**VL2** Two-stage operating valve.  
**VLP** Operating pilot valve.  
**VLR** Operating valve with pressure regulator.

**VP** Pilot valve.  
**VPS** VPS valve tightness control.  
**VS** Safety valve.  
**VSP** Safety pilot valve.  
**Ø** Gas train diameter.  
**Ø1** Main gas train diameter.  
**Ø2** Pilot gas train diameter.

● As standard.  
 ▲ As standard for burners with an output of more than 1200 kW, on request for burners with an output of less than 1200 kW.  
 ■ On request.  
 ◆ Mounted on burner.

# GAS TRAIN STRUCTURE AND COMPOSITION

## BE5

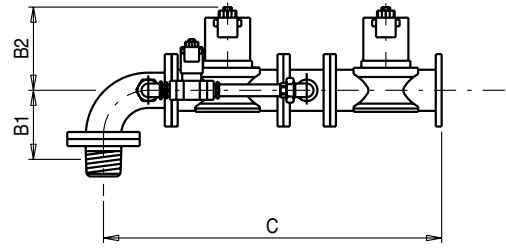
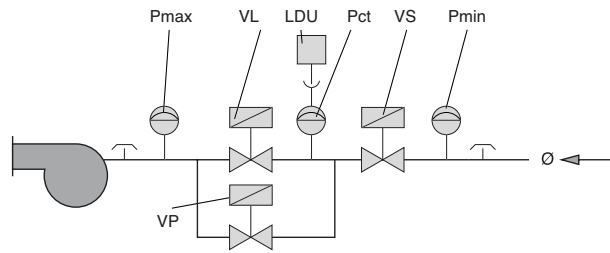

Gas train Part no.	Position								Gas train dimensions mm			Size of packaging mm	Weight
	LDU	Pct	Pmax	Pmin	VL	VP	VS	Ø	B1	B2	C	L x P x H	kg
19990460			●	●	DN65	1"1/2"	DN65	DN65	207	295	969	1260 x 650 x 600	63
19990461	●	●	●	●	DN65	1"1/2"	DN65	DN65	207	295	969	1260 x 650 x 600	64
19990462			●	●	DN80	1"1/2"	DN80	DN80	210	320	1016	1260 x 650 x 600	97
19990463	●	●	●	●	DN80	1"1/2"	DN80	DN80	210	320	1016	1260 x 650 x 600	98

## B7

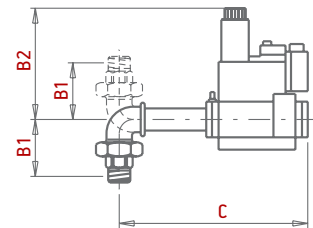
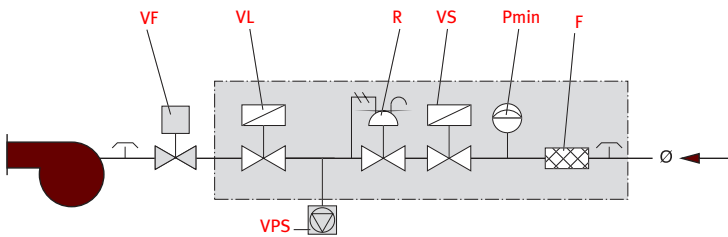

Gas train Part no.									Gas train dimensions mm			Size of packaging mm	Weight
	F	Pmin	R	VF	VL	VPS	VS	Ø	B1	B2	C	L x P x H	kg
19990545 (MB...407 - 3/4")	●	●	●	◆	●	■	●	3/4"	72	210	450	300 x 210 x 300	5
19990546 (MB...410 - 1")	●	●	●	◆	●	■	●	1"1/4	95	260	490	400 x 300 x 280	8
19990547 (MB...412 - 1"1/4")	●	●	●	◆	●	■	●	1"1/4	95	260	490	400 x 300 x 280	8
19990548 (MB...415 - 1"1/2")	●	●	●	◆	●	▲	●	1"1/2	103	170	600	460 x 250 x 460	11
19990549 (MB...420 - 2")	●	●	●	◆	●	▲	●	2"	114	220	600	460 x 250 x 460	13
19990550 (VGD20.503 - 2")	●	●	●	◆	●	▲	●	2"	114	285	890	990 x 300 x 500	15
19990563 (VGD40.065 - 2"1/2")	●	●	●	◆	●	▲	●	DN65	114	320	1120	1380 x 430 x 700	26
19990564 (VGD40.080 - 3")	●	●	●	◆	●	▲	●	DN80	114	325	1175	1380 x 430 x 700	28
19990609 (MB...420 - 2")	●	●	●	◆	●	▲	●	2"	114	220	600	460 x 250 x 460	13
19990628 (MB...415 - 1"1/2")	●	●	●	◆	●	▲	●	1"1/2	103	170	600	460 x 250 x 460	11
19990629 (VGD40.065 - 2"1/2")	●	●	●	◆	●	▲	●	DN65	125	320	760	1030 x 430 x 650	35
19990630 (VGD40.080 - 3")	●	●	●	◆	●	▲	●	DN80	175	325	860	1030 x 430 x 650	37

**CTV** Valve tightness control.  
**F** Filter.  
**LDU** LDU valve tightness control.  
**Pct** Pressure switch for gas control.  
**Pmax** Maximum pressure switch.  
**Pmc** Minimum and control pressure switch gas leaks.  
**Pmin** Minimum pressure switch.  
**R** Pressure regulator.  
**RF** Pressure regulator with filter.

**RFP** Pressure regulator with filter for pilot gas train.  
**RM** Manual flow rate regulator.  
**RP** Pneumatic regulator.  
**VF** Regulator throttle valve.  
**VL** Operating valve.  
**VL2** Two-stage operating valve.  
**VLP** Operating pilot valve.  
**VLR** Operating valve with pressure regulator.

**VP** Pilot valve.  
**VPS** VPS valve tightness control.  
**VS** Safety valve.  
**VSP** Safety pilot valve.  
**Ø** Gas train diameter.  
**Ø1** Main gas train diameter.  
**Ø2** Pilot gas train diameter.

● As standard.  
 ▲ As standard for burners with an output of more than 1200 kW, on request for burners with an output of less than 1200 kW.  
 ■ On request.  
 ◆ Mounted on burner.

# GAS TRAIN STRUCTURE AND COMPOSITION

## BE7

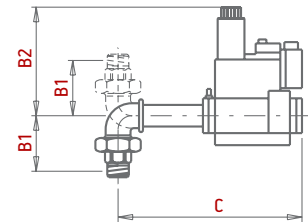
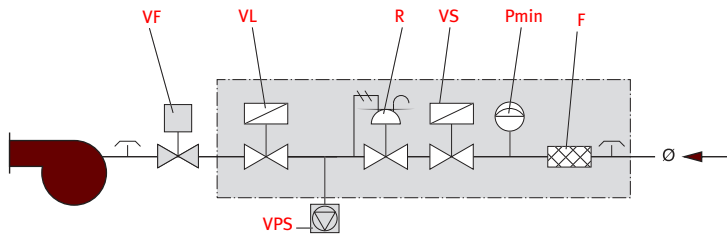

Gas train Part no.	Position								Gas train dimensions mm			Size of packaging mm	Weight
	F	Pmin	R	VF	VL	VPS	VS	Ø	B1	B2	C	L x P x H	kg
19990548 (MB...415 - 1"1/2)	●	●	●	◆	●	■	●	1"1/2	103	170	600	460 x 250 x 460	11
19990549 (MB...420 - 2")	●	●	●	◆	●	■	●	2"	114	220	600	460 x 250 x 460	13
19990550 (VGD20.503 - 2")	●	●	●	◆	●	■	●	2"	114	285	890	990 x 300 x 500	15
19990563 (VGD40.065 - 2"1/2)	●	●	●	◆	●	■	●	DN65	114	320	1120	1380 x 430 x 700	26
19990564 (VGD40.080 - 3")	●	●	●	◆	●	■	●	DN80	114	325	1175	1380 x 430 x 700	28
19990609 (MB...420 - 2")	●	●	●	◆	●	■	●	2"	114	220	600	460 x 250 x 460	13
19990628 (MB...415 - 1"1/2)	●	●	●	◆	●	■	●	1"1/2	103	170	600	460 x 250 x 460	11
19990629 (VGD40.065 - 2"1/2)	●	●	●	◆	●	■	●	DN65	125	320	760	1030 x 430 x 650	35
19990630 (VGD40.080 - 3")	●	●	●	◆	●	■	●	DN80	175	325	860	1030 x 430 x 650	37

## D2

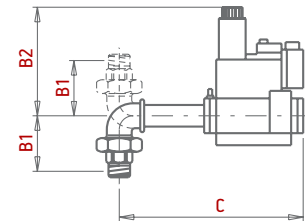
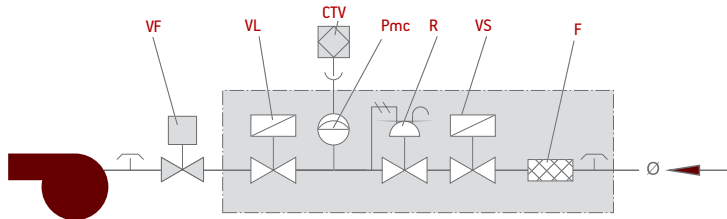

Gas train Part no.	Position								Gas train dimensions mm			Size of packaging mm	Weight
	CTV	F	Pmc	R	VF	VL	VS	Ø	B1	B2	C	L x P x H	kg
19990524 (VGD20.503 - 2")	●	●	●	●	◆	●	●	2"	114	285	890	990 x 300 x 500	14
19990525 (VGD40.065 - 2"1/2)	●	●	●	●	◆	●	●	DN65	114	320	1120	1380 x 430 x 700	26
19990526 (VGD40.080 - 3")	●	●	●	●	◆	●	●	DN80	114	325	1175	1380 x 430 x 700	28
19990555 (MB... 407 - 3/4")	●	●	●	●	◆	●	●	3/4"	72	140	350	300 x 210 x 300	5
19990556 (MB... 410 - 1")	●	●	●	●	◆	●	●	1"1/4	95	160	390	300 x 210 x 300	8
19990557 (MB... 412 - 1"1/4)	●	●	●	●	◆	●	●	1"1/4	95	160	390	300 x 210 x 300	8
19990558 (MB... 415 - 1"1/2)	●	●	●	●	◆	●	●	1"1/2	103	170	490	460 x 250 x 460	11
19990559 (MB... 420 - 2")	●	●	●	●	◆	●	●	2"	114	220	520	520 x 410 x 410	13
19990561 (MB... 415 - 1"1/2)	●	●	●	●	◆	●	●	1"1/2	103	170	490	520 x 410 x 410	11
19990562 (MB... 420 - 2")	●	●	●	●	◆	●	●	2"	114	220	520	520 x 410 x 410	13
19990573 (MB... 407 - 3/4")	●	●	●	●	◆	●	●	3/4"	72	160	305	400 x 300 x 280	12
19990574 (MB... 410 - 1")	●	●	●	●	◆	●	●	1"1/4	95	160	355	400 x 300 x 280	15
19990575 (MB... 412 - 1"1/4)	●	●	●	●	◆	●	●	1"1/4	95	160	355	400 x 300 x 280	15
19990576 (MB... 415 - 1"1/2)	●	●	●	●	◆	●	●	1"1/2	103	170	445	520 x 410 x 410	18
19990577 (VGD40.065 - 2"1/2)	●	●	●	●	◆	●	●	DN65	125	320	760	1030 x 430 x 650	50
19990578 (VGD40.080 - 3")	●	●	●	●	◆	●	●	DN80	175	325	860	1030 x 430 x 650	57

**CTV** Valve tightness control.  
**F** Filter.  
**LDU** LDU valve tightness control.  
**Pct** Pressure switch for gas control.  
**Pmax** Maximum pressure switch.  
**Pmc** Minimum and control pressure switch gas leaks.  
**Pmin** Minimum pressure switch.  
**R** Pressure regulator.  
**RF** Pressure regulator with filter.

**RFP** Pressure regulator with filter for pilot gas train.  
**RM** Manual flow rate regulator.  
**RP** Pneumatic regulator.  
**VF** Regulator throttle valve.  
**VL** Operating valve.  
**VL2** Two-stage operating valve.  
**VLP** Operating pilot valve.  
**VLR** Operating valve with pressure regulator.

**VP** Pilot valve.  
**VPS** VPS valve tightness control.  
**VS** Safety valve.  
**VSP** Safety pilot valve.  
**Ø** Gas train diameter.  
**Ø1** Main gas train diameter.  
**Ø2** Pilot gas train diameter.

● As standard.  
 ▲ As standard for burners with an output of more than 1200 kW, on request for burners with an output of less than 1200 kW.  
 ■ On request.  
 ◆ Mounted on burner.



# GAS TRAIN STRUCTURE AND COMPOSITION

## D3

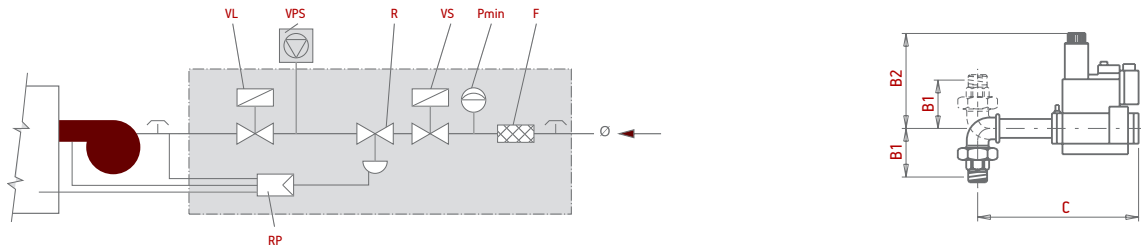

Gas train Part no.	Position								Gas train dimensions mm			Size of packaging mm L x P x H	Weight kg
	F	Pmin	R	RP	VL	VPS	VS	Ø	B1	B2	C		
19990440 (MB... 407 - 3/4")	●	●	●	●	●	■	●	3/4"	72	160	455	540 x 300 x 320	6
19990441 (MB... 412 - 1"1/4)	●	●	●	●	●	▲	●	1"1/4	95	175	500	520 x 410 x 410	9
19990442 (MB... 415 - 1"1/2)	●	●	●	●	●	▲	●	1"1/2	103	185	643	650 x 500 x 380	12
19990443 (MB... 420 - 2")	●	●	●	●	●	▲	●	2"	114	225	711	650 x 500 x 380	13
19990447 (MB... 407 - 3/4")	●	●	●	●	●	■	●	3/4"	72	160	455	540 x 300 x 320	6
19990448 (MB... 412 - 1"1/4)	●	●	●	●	●	▲	●	1"1/4	95	175	500	520 x 410 x 410	9
19990530 (VGD20.503 - 2")	●	●	●	●	●	▲	●	2"	114	331	890	990 x 300 x 500	15
19990531 (VGD40.065 - 2"1/2)	●	●	●	●	●	▲	●	DN65	114	365	1090	1380 x 430 x 700	26
19990537 (VGD40.080 - 3")	●	●	●	●	●	▲	●	DN80	114	375	1175	1380 x 430 x 700	28

## DE3

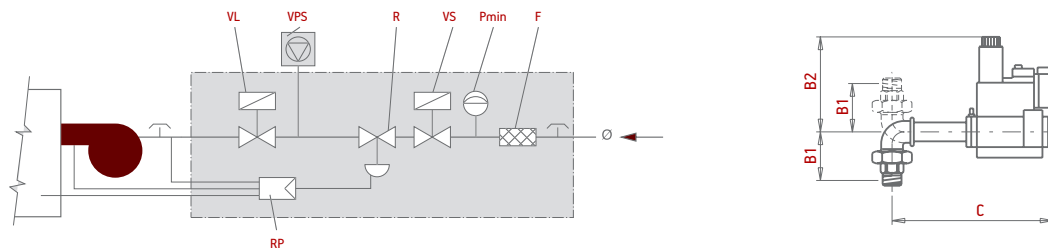

Gas train Part no.	Position								Gas train dimensions mm			Size of packaging mm L x P x H	Weight kg
	F	Pmin	R	RP	VL	VPS	VS	Ø	B1	B2	C		
19990441 (MB... 412 - 1"1/4)	●	●	●	●	●	■	●	1"1/4	95	175	500	520 x 410 x 410	9
19990442 (MB... 415 - 1"1/2)	●	●	●	●	●	■	●	1"1/2	103	185	643	650 x 500 x 380	12
19990443 (MB... 420 - 2")	●	●	●	●	●	■	●	2"	114	225	711	650 x 500 x 380	13
19990448 (MB... 412 - 1"1/4)	●	●	●	●	●	■	●	1"1/4	95	175	500	520 x 410 x 410	9
19990530 (VGD20.503 - 2")	●	●	●	●	●	■	●	2"	114	331	890	990 x 300 x 500	15
19990531 (VGD40.065 - 2"1/2)	●	●	●	●	●	■	●	DN65	114	365	1090	1380 x 430 x 700	26
19990537 (VGD40.080 - 3")	●	●	●	●	●	■	●	DN80	114	375	1175	1380 x 430 x 700	28

**CTV** Valve tightness control.  
**F** Filter.  
**LDU** LDU valve tightness control.  
**Pct** Pressure switch for gas control.  
**Pmax** Maximum pressure switch.  
**Pmc** Minimum and control pressure switch gas leaks.  
**Pmin** Minimum pressure switch.  
**R** Pressure regulator.  
**RF** Pressure regulator with filter.

**RFP** Pressure regulator with filter for pilot gas train.  
**RM** Manual flow rate regulator.  
**RP** Pneumatic regulator.  
**RF** Regulator throttle valve.  
**VL** Operating valve.  
**VL2** Two-stage operating valve.  
**VLP** Operating pilot valve.  
**VLR** Operating valve with pressure regulator.

**VP** Pilot valve.  
**VPS** VPS valve tightness control.  
**VS** Safety valve.  
**VSP** Safety pilot valve.  
**Ø** Gas train diameter.  
**Ø1** Main gas train diameter.  
**Ø2** Pilot gas train diameter.

● As standard.  
 ▲ As standard for burners with an output of more than 1200 kW, on request for burners with an output of less than 1200 kW.  
 ■ On request.  
 ◆ Mounted on burner.

# GAS TRAIN STRUCTURE AND COMPOSITION

## D4

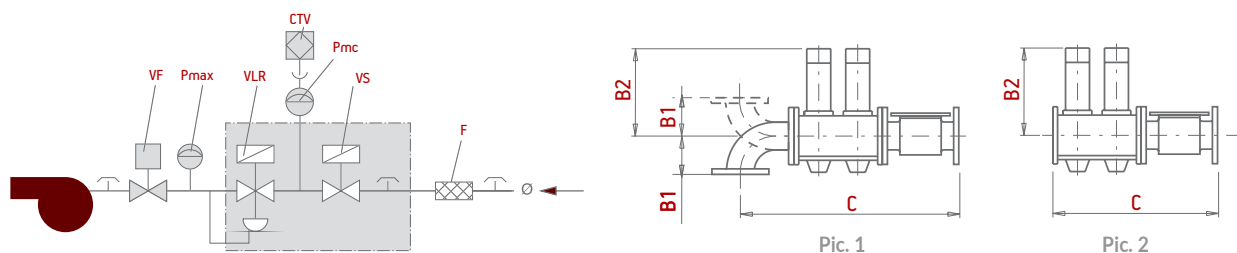

Gas train Part no.	Position							Gas train dimensions mm			Size of packaging mm L x P x H	Weight kg	Pic.	
	CTV	F	Pmax	Pmc	VF	VLR	VS	Ø	B1	B2				C
19990541 (VGD20.503 - 2")	●	2"	●	●	◆	●	●	2"	145	285	890	990 x 300 x 500	23	1
19990542 (VGD40.065 - 2"1/2)	●	DN65	●	●	◆	●	●	DN65	135	320	970	1380 x 430 x 700	36	1
19990543 (VGD40.080 - 3")	●	DN80	●	●	◆	●	●	DN80	135	325	1010	1380 x 430 x 700	38	1
19990544 (VGD40.100 - 4")	●	DN100	●	●	◆	●	●	DN100	175	330	1100	1380 x 430 x 700	44	1
19990587 (VGD20.503 - 2")	●	2"	●	●	◆	●	●	2"	-	285	530	650 x 500 x 380	19	2
19990588 (VGD40.065 - 2"1/2)	●	DN65	●	●	◆	●	●	DN65	-	320	580	830 x 430 x 640	26	2
19990589 (VGD40.080 - 3")	●	DN80	●	●	◆	●	●	DN80	-	325	630	830 x 430 x 640	29	2
19990590 (VGD40.100 - 4")	●	DN100	●	●	◆	●	●	DN100	-	330	730	830 x 430 x 640	40	2
19990606 (VGD40.080 - 3")	●	DN80	●	●	◆	●	●	DN80	165	325	1015	1380 x 430 x 700	38	1
19990607 (VGD40.100 - 4")	●	DN100	●	●	◆	●	●	DN100	175	330	1100	1380 x 430 x 700	44	1
19990608 (VGD40.125 - 5")	●	DN125	●	●	◆	●	●	DN125	170	350	1275	1580 x 430 x 720	60	1
19990626 (VGD40.150 - 6")	●	DN150	●	●	◆	●	●	DN150	170	370	1280	1580 x 430 x 720	95	1
19990666 (VGD2.065 - 2"1/2)	●	DN65	●	●	◆	●	●	DN65	135	285	1120	1380 x 430 x 700	45	1

## D5

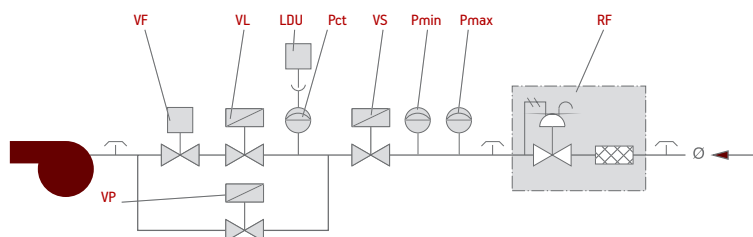

Burner model	Position									
	LDU	Pct	Pmax	Pmin	RF	VF	VL	VP	VS	Ø
COMIST 180 DSPNM	●	●	●	●	DN80	DN50	2"	1"1/2	DN65	DN80
COMIST 250 DSPGM	●	●	●	●	DN65	DN50	2"	1"1/2	DN65	DN65
COMIST 250 DSPNM	●	●	●	●	DN65	DN50	2"	1"1/2	DN65	DN65
COMIST 300 DSPGM	●	●	●	●	DN65	DN50	2"	1"1/2	DN65	DN65
COMIST 300 DSPNM	●	●	●	●	DN65	DN50	2"	1"1/2	DN65	DN65
GI MIST 350 DSPGM	●	●	●	●	DN65	DN50	2"	1"1/2	DN65	DN65
GI MIST 350 DSPNM-D	●	●	●	●	DN65	DN50	2"	1"1/2	DN65	DN65
GI MIST 420 DSPGM	●	●	●	●	DN80	DN65	DN65	1"1/2	DN65	DN80
GI MIST 420 DSPNM-D	●	●	●	●	DN80	DN65	DN65	1"1/2	DN65	DN80
GI MIST 510 DSPGM	●	●	●	●	DN80	DN80	DN80	1"1/2	DN80	DN80
GI MIST 510 DSPNM-D	●	●	●	●	DN80	DN80	DN80	1"1/2	DN80	DN80

**CTV** Valve tightness control.

**F** Filter.

**LDU** LDU valve tightness control.

**Pct** Pressure switch for gas control.

**Pmax** Maximum pressure switch.

**Pmc** Minimum and control pressure switch gas leaks.

**Pmin** Minimum pressure switch.

**R** Pressure regulator.

**RF** Pressure regulator with filter.

**RFP** Pressure regulator with filter for pilot gas train.

**RM** Manual flow rate regulator.

**RP** Pneumatic regulator.

**VF** Regulator throttle valve.

**VL** Operating valve.

**VLR** Two-stage operating valve.

**VLP** Operating pilot valve.

**VLR** Operating valve with pressure regulator.

**VP** Pilot valve.

**VPS** VPS valve tightness control.

**VS** Safety valve.

**VSP** Safety pilot valve.

**Ø** Gas train diameter.

**Ø1** Main gas train diameter.

**Ø2** Pilot gas train diameter.

● As standard.

▲ As standard for burners with an output of more than 1200 kW, on request for burners with an output of less than 1200 kW.

■ On request.

◆ Mounted on burner.

# GAS TRAIN STRUCTURE AND COMPOSITION

## DE5

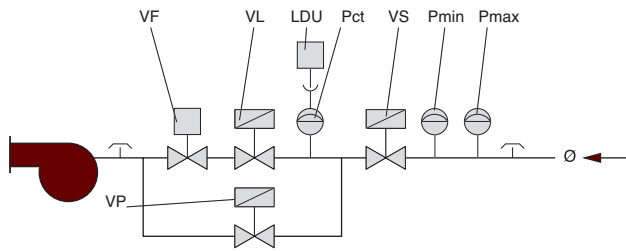

Burner model	Position								
	LDU	Pct	Pmax	Pmin	VF	VL	VP	VS	Ø
COMIST 180 DSPNM	●	●	●	●	DN50	2"	1"1/2	DN65	DN65
COMIST 250 DSPGM	●	●	●	●	DN50	2"	1"1/2	DN65	DN65
COMIST 250 DSPNM	●	●	●	●	DN50	2"	1"1/2	DN65	DN65
COMIST 300 DSPGM	●	●	●	●	DN50	2"	1"1/2	DN65	DN65
COMIST 300 DSPNM	●	●	●	●	DN50	2"	1"1/2	DN65	DN65
GI MIST 350 DSPGM	●	●	●	●	DN50	2"	1"1/2	DN65	DN65
GI MIST 350 DSPNM-D	●	●	●	●	DN50	2"	1"1/2	DN65	DN65
GI MIST 420 DSPGM	●	●	●	●	DN65	DN65	1"1/2	DN65	DN80
GI MIST 420 DSPNM-D	●	●	●	●	DN65	DN65	1"1/2	DN65	DN80
GI MIST 510 DSPGM	●	●	●	●	DN80	DN80	1"1/2	DN80	DN80
GI MIST 510 DSPNM-D	●	●	●	●	DN80	DN80	1"1/2	DN80	DN80

## D6

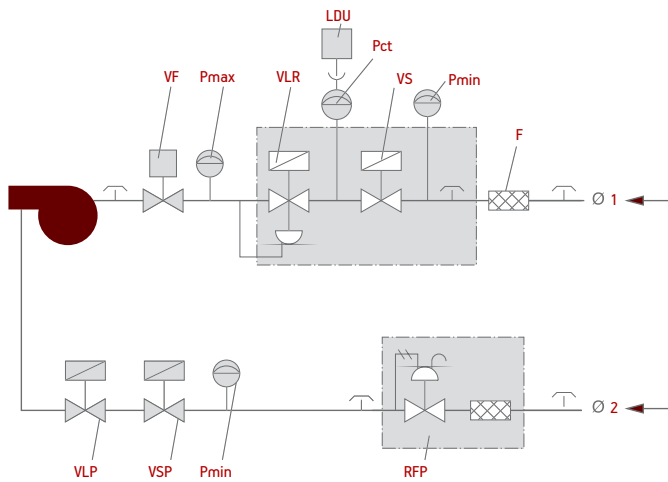

Burner model	Position													
	F	LDU	Pct	Pmax	Pmin	RFP	VF	VLP	VLR	VS	VSP	Ø1	Ø2	
GI MIST 1000 DSPGM (VGD40-80 3")	DN80	●	●	●	●	1/2"	DN80	1/2"	●	●	1/2"	DN80	1/2"	
GI MIST 1000 DSPNM-D (VGD40-80 3")	DN80	●	●	●	●	1/2"	DN80	1/2"	●	●	1/2"	DN80	1/2"	

**CTV** Valve tightness control.  
**F** Filter.  
**LDU** LDU valve tightness control.  
**Pct** Pressure switch for gas control.  
**Pmax** Maximum pressure switch.  
**Pmc** Minimum and control pressure switch gas leaks.  
**Pmin** Minimum pressure switch.  
**R** Pressure regulator.  
**RF** Pressure regulator with filter.

**RFP** Pressure regulator with filter for pilot gas train.  
**RM** Manual flow rate regulator.  
**RP** Pneumatic regulator.  
**RV** Regulator throttle valve.  
**VL** Operating valve.  
**VL2** Two-stage operating valve.  
**VLP** Operating pilot valve.  
**VLR** Operating valve with pressure regulator.

**VP** Pilot valve.  
**VPS** VPS valve tightness control.  
**VS** Safety valve.  
**VSP** Safety pilot valve.  
**Ø** Gas train diameter.  
**Ø1** Main gas train diameter.  
**Ø2** Pilot gas train diameter.

● As standard.  
 ▲ As standard for burners with an output of more than 1200 kW, on request for burners with an output of less than 1200 kW.  
 ■ On request.  
 ◆ Mounted on burner.

# GAS TRAIN STRUCTURE AND COMPOSITION

## D7

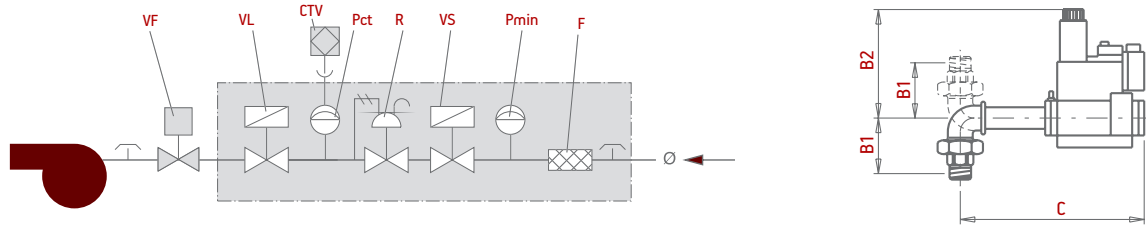

Gas train Part no.	Position									Gas train dimensions mm			Size of packaging mm L x P x H	Weight kg
	CTV	F	Pct	Pmin	R	VF	VL	VS	Ø	B1	B2	C		
19990580 (MB...410 - 1")	●	●	●	●	●	◆	●	●	1"1/4	95	160	390	300 x 210 x 300	8
19990581 (MB...412 - 1"1/4)	●	●	●	●	●	◆	●	●	1"1/4	95	160	390	300 x 210 x 300	8
19990582 (MB...415 - 1"1/2)	●	●	●	●	●	◆	●	●	1"1/2	103	170	490	460 x 250 x 460	11
19990583 (MB...420 - 2")	●	●	●	●	●	◆	●	●	2"	114	220	520	520 x 410 x 410	13
19990584 (VGD20.503 - 2")	●	●	●	●	●	◆	●	●	2"	114	285	890	990 x 300 x 500	15
19990585 (VGD40.065 - 2"1/2)	●	●	●	●	●	◆	●	●	DN65	114	320	1120	1380 x 430 x 700	26
19990586 (VGD40.080 - 3")	●	●	●	●	●	◆	●	●	DN80	114	325	1190	1380 x 430 x 700	28
19990624 (MB...420 - 2")	●	●	●	●	●	◆	●	●	2"	114	220	520	520 x 410 x 410	13

## D8

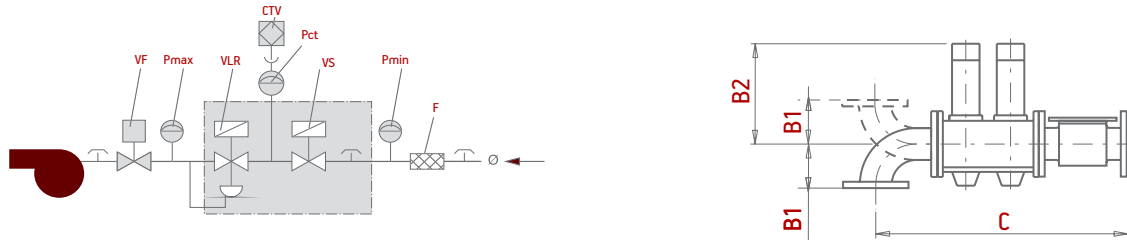

Gas train Part no.	Position									Gas train dimensions mm			Size of packaging mm L x P x H	Weight kg
	CTV	F	Pct	Pmax	Pmin	VF	VLR	VS	Ø	B1	B2	C		
19990599 (VGD20.503 - 2")	●	2"	●	●	●	◆	●	●	2"	145	285	890	990 x 300 x 500	23
19990600 (VGD40.065 - 2"1/2)	●	DN65	●	●	●	◆	●	●	DN65	135	320	970	1380 x 430 x 700	36
19990601 (VGD40.080 - 3")	●	DN80	●	●	●	◆	●	●	DN80	135	325	1010	1380 x 430 x 700	38
19990602 (VGD40.100 - 4")	●	DN100	●	●	●	◆	●	●	DN100	175	330	1100	1380 x 430 x 700	44
19990615 (VGD40.080 - 3")	●	DN80	●	●	●	◆	●	●	DN80	165	325	1015	1380 x 430 x 700	38
19990616 (VGD40.100 - 4")	●	DN100	●	●	●	◆	●	●	DN100	175	330	1100	1380 x 430 x 700	44
19990617 (VGD40.125 - 5")	●	DN125	●	●	●	◆	●	●	DN125	170	350	1275	1580 x 430 x 720	60
19990627 (VGD40.150 - 6")	●	DN150	●	●	●	◆	●	●	DN150	170	370	1280	1580 x 430 x 720	95
19990665 (VGD20.065 - 2"1/2)	●	DN65	●	●	●	◆	●	●	DN65	135	285	1120	1380 x 430 x 700	45

**CTV** Valve tightness control.  
**F** Filter.  
**LDU** LDU valve tightness control.  
**Pct** Pressure switch for gas control.  
**Pmax** Maximum pressure switch.  
**Pmc** Minimum and control pressure switch gas leaks.  
**Pmin** Minimum pressure switch.  
**R** Pressure regulator.  
**RF** Pressure regulator with filter.

**RFP** Pressure regulator with filter for pilot gas train.  
**RM** Manual flow rate regulator.  
**RP** Pneumatic regulator.  
**VF** Regulator throttle valve.  
**VL** Operating valve.  
**VLP** Two-stage operating valve.  
**VLR** Operating valve with pressure regulator.

**VP** Pilot valve.  
**VPS** VPS valve tightness control.  
**VS** Safety valve.  
**VSP** Safety pilot valve.  
**Ø** Gas train diameter.  
**Ø1** Main gas train diameter.  
**Ø2** Pilot gas train diameter.

● As standard.  
 ▲ As standard for burners with an output of more than 1200 kW, on request for burners with an output of less than 1200 kW.  
 ■ On request.  
 ◆ Mounted on burner.

# GAS TRAIN STRUCTURE AND COMPOSITION

## ME1

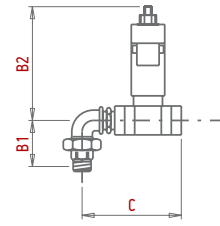
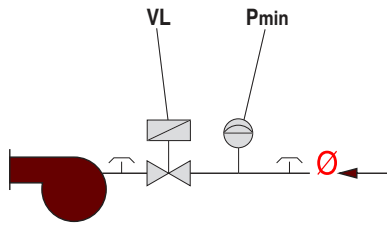

Gas train Part no.	Position			Gas train dimensions mm			Size of packaging mm	Weight kg
	Pmin	VL	Ø	B1	B2	C	L x P x H	
19990004	●	3/4"	3/4"	72	177	114	240 x 220 x 210	3
19990134	●	1"	1"	83	177	160	240 x 220 x 210	4
19990235	●	1/2"	1/2"	72	151	110	240 x 220 x 210	2

## M2

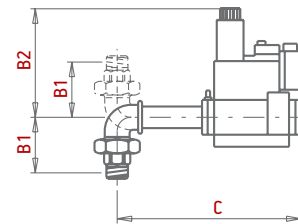
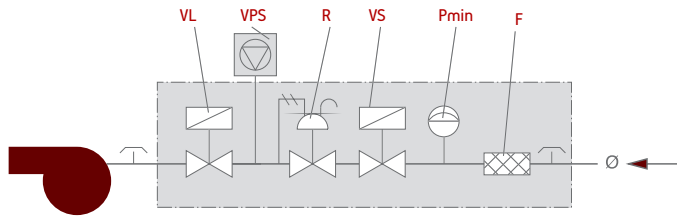

Gas train Part no.	Position							Gas train dimensions mm			Size of packaging mm	Weight kg
	F	Pmin	R	VL	VPS	VS	Ø	B1	B2	C	L x P x H	
19990002 (MB... 405 - 1/2")	●	●	●	●	■	●	3/4"	72	140	204	310 x 210 x 250	4
19990005 (MB... 407 - 3/4")	●	●	●	●	■	●	3/4"	72	140	204	310 x 210 x 250	4
19990008 (MB... 410 - 1")	●	●	●	●	■	●	1" 1/4	95	160	249	310 x 210 x 250	7
19990166 (MB... 412 - 1" 1/4)	●	●	●	●	■	●	1" 1/4	95	160	249	310 x 210 x 250	7
19990466 (MBC... 65 - 1/2")	●	●	●	●	●	●	1/2"	67	150	198	240 x 220 x 210	2
19990545 (MB... 407 - 3/4")	●	●	●	●	■	●	3/4"	72	140	450	300 x 210 x 300	5
19990546 (MB... 410 - 1")	●	●	●	●	■	●	1" 1/4	95	160	490	400 x 300 x 280	8
19990547 (MB... 412 - 1" 1/4)	●	●	●	●	■	●	1" 1/4	95	160	490	400 x 300 x 280	8
19990548 (MB... 415 - 1" 1/2)	●	●	●	●	■	●	1" 1/2	103	270	600	460 x 250 x 460	11
19990549 (MB... 420 - 2")	●	●	●	●	■	●	2"	114	330	600	650 x 500 x 380	13

**CTV** Valve tightness control.  
**F** Filter.  
**LDU** LDU valve tightness control.  
**Pct** Pressure switch for gas control.  
**Pmax** Maximum pressure switch.  
**Pmc** Minimum and control pressure switch gas leaks.  
**Pmin** Minimum pressure switch.  
**R** Pressure regulator.  
**RF** Pressure regulator with filter.

**RFP** Pressure regulator with filter for pilot gas train.  
**RM** Manual flow rate regulator.  
**RP** Pneumatic regulator.  
**RF** Regulator throttle valve.  
**VL** Operating valve.  
**VL2** Two-stage operating valve.  
**VLP** Operating pilot valve.  
**VLR** Operating valve with pressure regulator.

**VP** Pilot valve.  
**VPS** VPS valve tightness control.  
**VS** Safety valve.  
**VSP** Safety pilot valve.  
**Ø** Gas train diameter.  
**Ø1** Main gas train diameter.  
**Ø2** Pilot gas train diameter.

● As standard.  
 ▲ As standard for burners with an output of more than 1200 kW, on request for burners with an output of less than 1200 kW.  
 ■ On request.  
 ◆ Mounted on burner.

# GAS TRAIN STRUCTURE AND COMPOSITION

## ME4

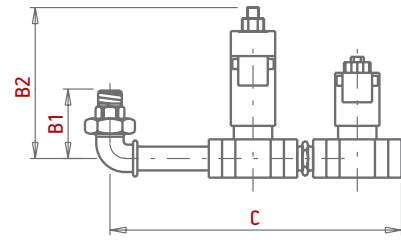
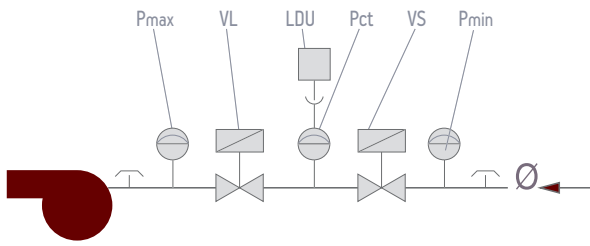

Gas train Part no.	Position							Gas train dimensions mm			Size of packaging mm	Weight
	LDU	Pct	Pmax	Pmin	VL	VS	Ø	B1	B2	C	L x P x H	kg
19990471			●	●	1" 1/2	1" 1/2	1" 1/2	103	205	540	520 x 410 x 410	13

**CTV** Valve tightness control.  
**F** Filter.  
**LDU** LDU valve tightness control.  
**Pct** Pressure switch for gas control.  
**Pmax** Maximum pressure switch.  
**Pmc** Minimum and control pressure switch gas leaks.  
**Pmin** Minimum pressure switch.  
**R** Pressure regulator.  
**RF** Pressure regulator with filter.

**RFP** Pressure regulator with filter for pilot gas train.  
**RM** Manual flow rate regulator.  
**RP** Pneumatic regulator.  
**VF** Regulator throttle valve.  
**VL** Operating valve.  
**VL2** Two-stage operating valve.  
**VLP** Operating pilot valve.  
**VLR** Operating valve with pressure regulator.

**VP** Pilot valve.  
**VPS** VPS valve tightness control.  
**VS** Safety valve.  
**VSP** Safety pilot valve.  
**Ø** Gas train diameter.  
**Ø1** Main gas train diameter.  
**Ø2** Pilot gas train diameter.

● As standard.  
 ▲ As standard for burners with an output of more than 1200 kW, on request for burners with an output of less than 1200 kW.  
 ■ On request.  
 ◆ Mounted on burner.

NOTE

A large grey rectangular block is positioned at the top of the page, directly below the 'NOTE' header. Below this block, the page is filled with a series of horizontal lines, providing a space for writing notes.

NOTE

A large grey rectangular block at the top of the page, followed by a series of horizontal lines for writing.





CERTIFICATE  
CERTIFICATE No. 02008

A CERTIFICATE OF REGISTRATION HAS BEEN ISSUED TO THE ORGANIZATION

**BALTUR S.p.A.**

via Ferraresa, 10 - 44042 Cento (FE)  
Italy

FOR THE IMPLEMENTATION OF THE STANDARD

**UNI EN ISO 9001:2015**

Design, production and service of burners and boilers. Trade of heating systems, hot air generators, air-conditioners, chillers and air renewal units, fan coil units, water heaters, boilers and thermal solar systems.

ISO 9001:2015

The organization provides a Quality Management System that conforms to the requirements of the standard, and which is certified by the certification body. The certification body has verified the effectiveness of the system and the compliance of the organization with the requirements of the standard. The certification body has also verified the compliance of the organization with the requirements of the standard. The certification body has also verified the compliance of the organization with the requirements of the standard. The certification body has also verified the compliance of the organization with the requirements of the standard.

Issue date: 2021-07-15  
Valid until: 2024-07-15  
Last renewal: 2021-07-15



ICIM S.p.A.  
Via Ferraresa, 10 - 44042 Cento (FE) - Italy



ACCREDITED  
BY THE  
UNION OF  
TESTING  
CERTIFICATION  
BODIES  
IN EUROPE  
UNION



CISA  
Via Ferraresa, 10 - 44042 Cento (FE) - Italy

02008-001

© The IQNet logo is a registered trademark of IQNet. All other trademarks are the property of their respective owners.

© The ACCREDITED logo is a registered trademark of the Union of Testing Certification Bodies in Europe (UNION OF TESTING CERTIFICATION BODIES IN EUROPE). All other trademarks are the property of their respective owners.

© The CISA logo is a registered trademark of CISA. All other trademarks are the property of their respective owners.

© The IQNet logo is a registered trademark of IQNet. All other trademarks are the property of their respective owners.

© The ACCREDITED logo is a registered trademark of the Union of Testing Certification Bodies in Europe (UNION OF TESTING CERTIFICATION BODIES IN EUROPE). All other trademarks are the property of their respective owners.

© The CISA logo is a registered trademark of CISA. All other trademarks are the property of their respective owners.

© The IQNet logo is a registered trademark of IQNet. All other trademarks are the property of their respective owners.